

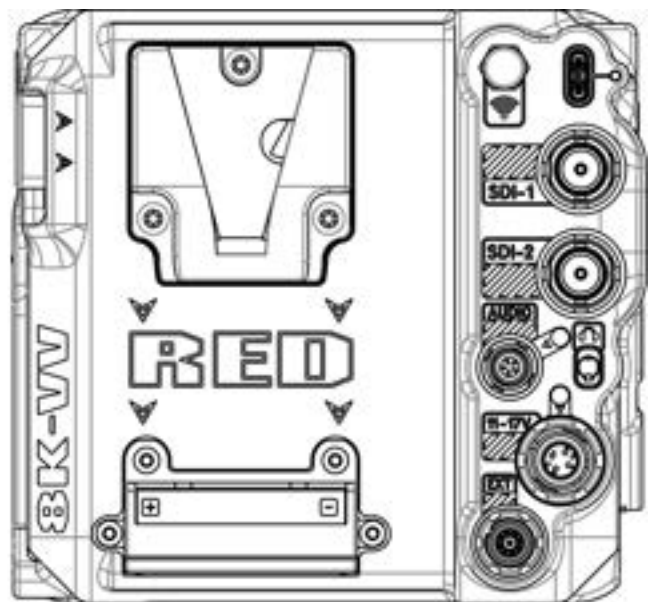

# V-RAPTOR™ 8K VV OPERATION GUIDE

---

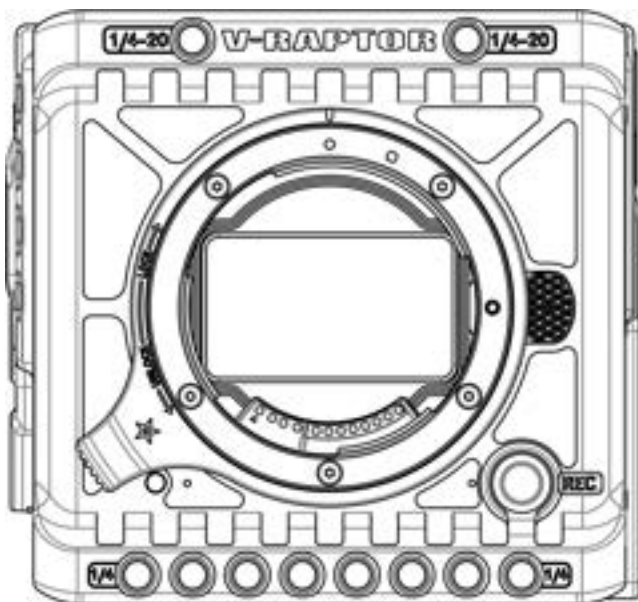

---

V-RAPTOR 8K VV | V1.1, REV. A

[RED.COM](http://RED.COM)

# TABLE OF CONTENTS

<b>DISCLAIMER</b> .....	<b>IV</b>	HIGHLIGHT ROLL-OFF .....	62
<b>SAFETY INSTRUCTIONS</b> .....	<b>VI</b>	3D LUT .....	62
<b>1. INTRODUCTION</b>		CDL .....	64
V-RAPTOR™ 8K VV + 6K S35 (DUAL FORMAT) .	1	EXPOSURE ADJUST .....	68
<b>2. QUICK REFERENCE</b>		<b>PROJECT SETTINGS MENU</b> .....	69
PREPARING THE CAMERA HARDWARE .....	4	FORMAT .....	70
PREPARING THE CAMERA SYSTEM .....	4	RECORDING FRAME RATE .....	78
CONFIGURING THE SETTINGS .....	4	PROJECT TIME BASE .....	79
RECORDING .....	4	R3D QUALITY .....	80
PROCESSING FOOTAGE .....	4	PRE-RECORD .....	80
<b>3. CAMERA COMPONENTS</b>		SLATE .....	81
CAMERA BODY .....	5	<b>AUDIO / TC MENU</b> .....	82
CAMERA BODY CONTROLS AND FEATURES .....	5	AUDIO SOURCE .....	84
FRONT .....	5	INTERNAL MICROPHONE (CH 1/2) .....	84
BACK .....	6	EXTERNAL (CH 3/4) .....	85
LEFT .....	7	HEADPHONE .....	86
RIGHT .....	8	TIMECODE SOURCE .....	87
TOP .....	9	TIMECODE DISPLAY MODE .....	88
BOTTOM .....	10	<b>MONITORING MENU</b> .....	88
CAMERA BODY LEDS .....	11	TOP LCD .....	89
REDOVOLT MICRO-V BATTERY .....	15	SDI 1 / 2 .....	90
RED COMPACT DUAL V-LOCK CHARGER .....	16	LIVE STREAM .....	97
COMPATIBLE BATTERIES .....	16	TOOLS .....	98
LENSES AND ADAPTORS .....	17	GUIDES .....	104
RED CFEXPRESS TYPE B MEDIA .....	19	<b>MEDIA MENU</b> .....	111
RED CFEXPRESS TYPE B READER .....	20	EJECT .....	111
OUTRIGGER HANDLE .....	21	MEDIA INFO .....	112
V-RAPTOR WING GRIP .....	21	SECURE FORMAT .....	112
DSMC3 RED® TOUCH 7.0" LCD .....	22	<b>USER SETTINGS MENU</b> .....	115
LCD .....	24	PRESETS .....	115
LCD NAVIGATION .....	24	SIDE LCD CONTROL PANELS .....	118
MENUS .....	25	USER 1, 2, 3 .....	118
PAGES .....	26	<b>AUTOFOCUS - BETA MENU</b> .....	120
HOME PAGE .....	29	ENABLE .....	120
HISTOGRAM PAGE .....	33	MODE .....	121
TOOLS PAGE .....	36	SIZE .....	121
SDI PAGE .....	39	POSITION .....	122
AUDIO CHANNELS 1 AND 2 PAGE .....	40	<b>COMMUNICATION MENU</b> .....	123
AUDIO CHANNELS 3 / 4 PAGE .....	42	CAMERA .....	123
HEADPHONE PAGE .....	44	USB-C .....	124
USER PAGES .....	46	WI-FI .....	126
PLAYBACK .....	46	FTPS .....	134
RED CONTROL APP .....	49	SERIAL .....	134
STATUS BAR .....	50	<b>SYSTEM SETTINGS MENU</b> .....	136
<b>4. MENUS</b>		DATE / TIME .....	137
IMAGE / LUT MENU .....	55	LENS .....	138
ISO .....	56	POWER .....	139
SHUTTER .....	56	INDICATORS .....	140
WHITE BALANCE .....	58	STATUS SETTINGS .....	140
OUTPUT COLOR SPACE .....	61	SYSTEM STATUS .....	142
OUTPUT TONE MAP .....	61	<b>LANGUAGE MENU</b> .....	144
		<b>MAINTENANCE MENU</b> .....	144
		CALIBRATE .....	145
		CALIBRATION .....	146
		SAVE LOG .....	146
		RESET DEFAULTS .....	147
		FACTORY RESET .....	147
		UPGRADE .....	147

## 5. HOW TO

WI-FI CONFIGURATION .....	148
CONNECTING WIRELESSLY TO AN EXISTING WI-FI NETWORK .....	148
FTPS CONFIGURATION .....	151
CAMERA SET-UP .....	151
SOFTWARE SET-UP (FILEZILLA) .....	152
ADDITIONAL INFORMATION .....	153
USB-C CONFIGURATION .....	154
USB-C ANDROID CONFIGURATION .....	155
USB-C APPLE CONFIGURATION .....	161
USB-C ETHERNET CONFIGURATION .....	168
POWER .....	171
ATTACHING THE BATTERY .....	171
REMOVING THE BATTERY .....	171
POWER COMPONENTS .....	171
V-RAPTOR 8K VV POWER ADAPTOR .....	172
AUTO BOOT ON POWER .....	172
POWER CONSUMPTION .....	172
POWER PRIORITY .....	172
TURNING ON THE CAMERA .....	173
TURNING OFF THE CAMERA .....	174
MEDIA MANAGEMENT .....	174
EJECTING MEDIA .....	174
INSERTING MEDIA .....	176
SECURE FORMAT .....	178
MEDIA INFORMATION .....	179
FILE SYSTEM .....	179
CLIP FOLDER NAMING CONVENTION .....	180
CLIP METADATA .....	180
MEDIA BEST PRACTICES .....	181
RED MONITOR INTERFACE CABLE .....	182
MONITORING .....	182
DSMC3 RED® TOUCH 7.0" LCD .....	182
SDI OUTPUT TO A MONITOR .....	182
RED CONTROL .....	185
USB-C .....	186
EXPOSURE .....	187
FALSE COLOR EXPOSURE TOOLS .....	187
FOCUS .....	188
FOCUS PEAKING MODE .....	188
EDGE PEAKING MODE .....	188
PEAKING PEAKING MODE .....	189
TIMECODE .....	189
TIME OF DAY .....	189
EDGE CODE .....	191
ZEBRA MODES .....	192
ZEBRA OVERVIEW .....	192
PRE-RECORDING CONTENT .....	193
CALIBRATING THE SENSOR .....	194
WHEN TO CALIBRATE THE SENSOR .....	194
UPGRADING THE FIRMWARE .....	194
VERIFYING THE FIRMWARE VERSION .....	194
UPGRADING THE FIRMWARE .....	194
SYSTEM MAINTENANCE .....	197

EXTERIOR SURFACES .....	197
STORAGE .....	197
LCD SCREEN .....	198
WATER DAMAGE .....	198

## 6. TROUBLESHOOTING

GENERAL TROUBLESHOOTING TIPS .....	199
CONTACT SUPPORT .....	199
STATUS ICONS .....	200

## 7. MECHANICAL DRAWINGS

FRONT VIEW .....	202
BACK VIEW .....	203
RIGHT SIDE VIEW .....	204
LEFT SIDE VIEW .....	205
TOP VIEW .....	206
BOTTOM VIEW .....	207
FEMALE RP SMA PORT .....	208
USB-C PORT .....	209
12G-SDI (SDI-1 & SDI-2) .....	210
12G-SDI 75 OHM MALE BNC CONNECTOR .....	210
AUDIO PORT .....	212
5-PIN 00B FEMALE AUDIO CONNECTOR .....	212
HEADPHONE JACK .....	213
6-PIN DC-IN .....	214
6-PIN 1B DC INPUT CONNECTOR .....	214
COMPATIBLE CABLES .....	214
EXTENSION PORT .....	215
9-PIN 0B ODU EXTENSION PORT PINOUT .....	215
COMPATIBLE CABLES .....	215

## 8. MENU MAP .....

## 9. TECHNICAL SPECIFICATIONS .....

## DISCLAIMER

RED® has made every effort to provide clear and accurate information in this document, which is provided solely for the user's information. While thought to be accurate, the information in this document is provided strictly "as is" and RED will not be held responsible for issues arising from typographical errors or user's interpretation of the language used herein that is different from that intended by RED. All safety and general information is subject to change as a result of changes in local, federal or other applicable laws.

RED reserves the right to revise this document and make changes from time to time in the content hereof without obligation to notify any person of such revisions or changes. In no event shall RED, its employees or authorized agents be liable to you for any damages or losses, direct or indirect, arising from the use of any technical or operational information contained in this document.

This document was generated on 10/22/2021. To see earlier versions of this document, submit a Support ticket at <https://support.red.com>. For comments or questions about content in this document, send a detailed email to [OpsGuides@red.com](mailto:OpsGuides@red.com).

### COPYRIGHT NOTICE

COPYRIGHT© 2021 RED.COM, LLC

All trademarks, trade names, logos, icons, images, written material, code, and product names used in association with the accompanying product are the copyrights, trademarks, or other intellectual property owned and controlled exclusively by RED.COM, LLC. For a comprehensive list, see [www.red.com/trademarks](http://www.red.com/trademarks).

### TRADEMARK DISCLAIMER

All other company, brand, and product names are trademarks or registered trademarks of their respective holders. RED has no affiliation to, is not associated with or sponsored by, and has no express rights in third-party trademarks. Adobe and Adobe Premiere Pro are registered trademarks of Adobe Systems Incorporated. DaVinci and DaVinci Resolve are registered trademarks of Blackmagic Design in the U.S. and other countries. Leica is a registered trademark of Leica Microsystems. Canon is a registered trademark of Canon, U.S.A. Apple, iOS, Macintosh, Final Cut Pro, and QuickTime are registered trademarks of Apple Inc. in the U.S. and other countries. Windex is a registered trademark of S. C. Johnson & Son, Inc. Windows is a registered trademark of Microsoft Corporation. Avid is a registered trademark of Avid Technology, Inc. FileZilla is a registered trademark of its respective owners. Nuke™ is a trademark of The Foundry Visionmongers Ltd. SCRATCH is a registered trademark ® of ASSIMILATE, 2006. SCRATCH SCAFFOLDS, SCRATCH EXTENSIONS, and SCRATCH Digital Intermediate Process Solution are all trademarks and registered trademarks of ASSIMILATE, 2006, All rights reserved. Autodesk, the Autodesk logo, Flame are registered trademarks or trademarks of Autodesk, Inc., and/or its subsidiaries and/or affiliates in the USA and/or other countries.

### COMPLIANCE STATEMENTS

#### INDUSTRIAL CANADA EMISSION COMPLIANCE STATEMENTS

This device complies with Industry Canada license-exempt RSS standards RSS 139 and RSS 210. Operation is subject to the following two conditions: (1) this device may not cause interference, and (2) this device must accept any interference, including interference that may cause undesired operation of the device.

This Class B digital apparatus complies with Canadian ICES-003.

To comply with FCC and Industry Canada RF exposure limits for general population/ uncontrolled exposure, the antenna(s) used for this transmitter must be installed to provide a separation distance of 70 mm from all persons and operating in conjunction with any other antenna or transmitter, except in accordance with FCC multi-transmitter product procedures.

Other user manual statements may apply.

Le présent appareil est conforme aux CNR d'Industrie Canada applicables aux appareils radio exempts de licence. L'exploitation est autorisée aux deux conditions suivantes : (1) l'appareil ne doit pas produire de brouillage, et (2) l'utilisateur de l'appareil doit accepter tout brouillage radioélectrique subi, même si le brouillage est susceptible d'en compromettre le fonctionnement.

Cet appareil numérique de la classe B est conforme à la norme NMB-003 du Canada.

Pour se conformer aux limites d'exposition aux RF de la FCC et d'industries Canada pour la population générale/ exposition non contrôlée, l'antenne(s) utilisée pour ce transmetteur doit être installée pour fournir une distance de séparation d'au moins 70 mm de toutes les personnes et fonctionnant conjointement avec une autre antenne ou émetteur, sauf en conformité avec les procédures de produits multi-émetteur FCC.

Autres d'éclairations manuel de l'utilisateur peuvent s'appliquer.

### FEDERAL COMMUNICATIONS COMMISSION (FCC) STATEMENTS

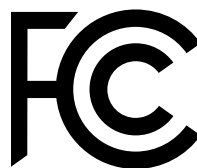

This equipment has been tested and found to comply with the limits for a Class A digital device, pursuant to part 15 of the FCC Rules. These limits are designed to provide reasonable protection against harmful interference when the equipment is operated in a commercial environment. This equipment generates, uses,

and can radiate radio frequency energy and, if not installed and used in accordance with the instruction manual, may cause harmful interference to radio communications. Operation of this equipment in a residential area is likely to cause harmful interference in which case the user will be required to correct the interference at his own expense.

To maintain compliance with FCC regulations, shielded cables must be used with this equipment. Operation with non-approved equipment or unshielded cables is likely to result in interference to radio and TV reception. The user is cautioned that changes and modifications made to the equipment without the approval of manufacturer could void the users authority to operate this equipment.

This device complies with Part 15 of the FCC Rules.

Operation is subject to the following two conditions (1) this device may not cause harmful interference, and (2) this device must accept any interference received, including interference that may cause undesired operation.



**CAUTION:** Exposure to Radio Frequency Radiation.

The device shall be used in such a manner that the potential for human contact is minimized.

This equipment complies with FCC radiation exposure limits set forth for an uncontrolled environment. This equipment should be installed and operated with a minimum distance of 20 cm between the radiator and your body.



**CAUTION:** Regulations of the FCC and FAA prohibit airborne operation of radio-frequency wireless devices because their signals could interfere with critical aircraft instruments.



**CAUTION:** If the device is changed or modified without permission from RED, the user may void his or her authority to operate the equipment.

## AUSTRALIA AND NEW ZEALAND STATEMENTS

RED declares that the radio equipment described in this document complies with the following international standards:

- IEC 62368-1 – Product Safety
- ETSI EN 300 328 – Technical requirement for radio equipment

RED declares digital devices described in this document comply with the following Australian and New Zealand standards:

- AS/NZS CISPR 22 – Electromagnetic Interference
- AS/NZS 61000.3.2 – Power Line Harmonics
- AS/NZS 61000.3.3 – Power Line Flicker

## SINGAPORE STATEMENTS

Complies with IMDS Standards N3434-20.

## THAILAND STATEMENTS

This telecommunication equipment conforms to NTC/NBTC technical requirements.

## JAPAN STATEMENTS

This equipment contains specified radio equipment that has been certified to the Technical Regulation Conformity Certification under the Radio Law.

本機器は、電波法に基づく技術基準適合証明等を受けた特定無線デバイスを使用しております。



## EUROPEAN UNION COMPLIANCE STATEMENTS



RED declares that the radio equipment described in this document complies with the EMC Directive (2014/30/EU) and the Low Voltage Directive (2014/35/EU) issued by the Commission of the European Community.

Compliance with this directive implies

conformity to the following European Norms (in brackets are the equivalent international standards).

- EN 62368-1 (IEC 62368-1) – Product Safety
- ETSI EN 300 328 Technical requirement for radio equipment
- ETSI EN 301 489 General EMC requirements for radio equipment
- EN 55032 (CISPR 32) Electromagnetic Compatibility
- EN 55035 (CISPR 35) Immunity Requirements
- EN 61000-3-2 (IEC 61000-3-2) Harmonic Current Emissions
- EN 61000-3-3 (IEC 61000-3-3) Voltage changes, voltage fluctuations and flicker
- EU 2015/863 RoHS Directive

## WASTE ELECTRICAL AND ELECTRONIC EQUIPMENT (WEEE)

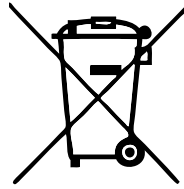

The Waste Electrical and Electronic Equipment (WEEE) mark applies only to countries within the European Union (EU) and Norway. This symbol on the product and accompanying documents means that used electrical and electronic products should not be mixed with general household waste. For proper treatment, recovery and recycling, take this product to designated collection points where it will be accepted free of charge. Alternatively, in some countries you may be able to return your

products to your local retailer upon purchase of an equivalent new product.

Disposing of this product correctly will help save valuable resources and prevent any potential negative effects on human health and the environment, which could otherwise arise from inappropriate waste handling. Contact your local authority for further details of your nearest designated collection point. Penalties may be applicable for incorrect disposal of this waste, in accordance with your national legislation. For business users in the European Union, if you wish to discard electrical and electronic equipment, contact your dealer or supplier for further information.

## RESPONSIBLE PARTY

RED Digital Cinema  
94 Icon  
Lake Forest, CA 92610  
USA



# SAFETY INSTRUCTIONS

- DO NOT use the camera or accessories near water. Avoid exposing your camera to moisture. The unit is not waterproof, so contact with water could cause permanent damage to the unit as well as electric shock and serious injury to the user. DO NOT use the camera in the rain or under other conditions with high moisture without appropriate protection, and immediately remove power source if camera or accessories are exposed to moisture.



**WARNING:** To reduce the risk of fire or electric shock, do not expose the camera to rain or moisture.

- DO NOT expose the camera to laser beams, as laser beams may damage the sensor.
- DO NOT expose your camera to excessive vibration or impact (shock). Be careful not to drop your camera. Internal mechanisms may be damaged by severe shock. Mechanical alignment of optical elements may be affected by excessive vibration.
- ELECTROMAGNETIC INTERFERENCE:** The use of devices using radio or other communication waves may result in the malfunction or interference with the unit and/or with audio and video signals.
- Clean only using a dry cloth. When cleaning your camera, remember that it is not waterproof and moisture can damage electronic circuitry. DO NOT rinse or immerse any element of the camera, lens or other accessory, keep them dry at all times. DO NOT use soaps, detergents, ammonia, alkaline cleaners, and abrasive cleaning compounds or solvents. These substances may damage lens coatings and electronic circuitry.
- Maintain sufficient ventilation—DO NOT block any ventilation openings or obstruct cooling fan airflow.



**CAUTION:** Proper camera ventilation requires a minimum 0.5" (1.25 cm) clearance between the camera ventilation openings and external surfaces. Verify that objects that can block the fan intake and exhaust ports do not impede airflow. Failure to permit adequate airflow may result in overheating of the camera, degraded operation, and in extreme situations, damage to the camera.



**WARNING:** Media cards can become very hot during prolonged recording sessions. When ejecting the media card, let it cool before touching it with bare fingers.

- DO NOT operate or store near any heat sources such as radiators, heat registers, stoves, or any other apparatuses that produce heat. Store in a protected, level and ventilated place. Avoid exposure to temperature extremes, damp, severe vibration, strong magnetic fields, direct sunlight or local heat sources during storage. Remove any batteries from the camera before storage. Recommended storage and usage temperatures for your camera, lenses and other accessories are:
  - Operating range: 32° F to 104° F (0° C to 40° C)
  - Storage range: -4° F to 122° F (-20° C to 50° C)
- If there are any performance issues with your camera or accessories when operating within this temperature range, submit a support ticket to <https://support.red.com>.

- DO NOT bypass the third prong of the grounding-type plug on the power cord of the included power Adaptor. A grounding-type plug has two blades and a third "grounding" prong. The third prong is provided for your safety. You must connect the plug to an outlet with a protective earth connection. If the grounding-type plug does not fit into your outlet, do not attempt to modify the plug or outlet, consult a qualified electrician.
- Protect all power cords from being pinched, walked on, or driven over by a vehicle. Replace any power cords suspected of sustaining damage due to crushing or other forms physical damage.



**CAUTION:** Install this camera in a proper support system that can handle the entire weight of the camera and the accessories. Secure the camera by using the ¼-20 and/or the 3/8-16 mounting points located on the bottom of the camera. Always verify that the screws are tightened properly. When the camera is not properly attached, or is placed on an unstable surface, the camera can fall and cause injury or be damaged.



**CAUTION:** Products marked with this symbol are class 2 devices. These double insulated devices are not provided with a grounding type plug.



**CAUTION:** The power cord plug for the included power adaptor is used as the power disconnect. To disconnect all power from the power adaptor, unplug the power cord plug from the wall outlet. During use, the power cord plug should remain easily accessible at all times.

- Lithium-ion batteries may be subject to special handling requirements pursuant to federal and local laws. Refer to specific shipping instructions included with your battery regarding proper transport of your battery. Do not handle your battery if it is damaged or leaking. Disposal of batteries must be in accordance with local environmental regulations. For example, California law requires that all rechargeable batteries must be recycled by an authorized recycle center. Storing batteries fully charged or in high temperature conditions may permanently reduce the life of the battery. Available battery capacity may also be temporarily lessened after storage in low temperature conditions.



**WARNING:** DO NOT expose the battery to excessive heat.



**CAUTION:** Refer all service and repair to qualified RED service personnel. To reduce the risk of electric shock, and damage to the camera or accessories, DO NOT attempt to perform any servicing other than any procedures that are recommended in the operating instructions.



**INDOOR USE ONLY:** This device is designed primarily for indoor use.

- El aparato no debe quedar expuesto a goteo o salpicaduras por líquidos.

## BATTERY STORAGE AND HANDLING



**WARNING:** Failure to read, understand, and follow these instructions may result in overheating, chemical leakage, smoke emission, fire, or other potentially harmful results.

- Read and adhere to all safety instructions provided by the manufacturer of the batteries.
- Always follow proper battery handling and storage practices. Improper handling and failure to abide by proper storage instructions may cause permanent damage to batteries, or degrade battery charge holding capacity. Improper handling practices or failure to comply with instructions may also put you at risk.
- Lithium-Ion batteries, like the REDVOLT Micro-V, self-discharge over time. When storing for long periods of time, store batteries separately from the camera or charger and remember to charge batteries to a capacity level of 40% to 60%. If batteries will be stored for long periods of time, RED recommends that you check the charge level at least once every six (6) months, and recharge batteries to a capacity level of 40% to 60%.
- When not in use, remove the battery from the camera or charger and store the battery in a cool, dry place. Avoid extreme hot temperatures (such as inside a hot car), corrosive gas, and direct sunlight. The optimal storage temperature for batteries is between -4° F to 68° F (-20° C to 20° C).



**WARNING:** Batteries stored in a discharged state for long periods of time may self-discharge and lose the ability to hold a charge.



**WARNING:** If recharging operation fails to complete even after a specified recharging time has elapsed, immediately stop further recharging.

- DO NOT put the battery into a microwave oven or a pressurized container.
  - DO NOT use or subject the battery to intense sunlight or hot temperatures such as in a car in hot weather.
  - DO NOT use it in a location where static electricity may be present.
  - DO NOT exceed the recharging temperature range of 32° F to 104° F (0° C to 40° C).
  - Store the battery in a location where children cannot reach it.
  - If the battery leaks or gives off a bad odor, discontinue use immediately.
  - If the battery gives off an odor, generates heat, becomes discolored or deformed, or in any way appears abnormal during use, recharging or storage, immediately remove it from the equipment or battery charger and discontinue use.
  - If electrolyte begins leaking from the battery and comes into contact with your skin or clothing, immediately wash it away with running water. Failure to do this may result in skin inflammation.
  - If the battery leaks and the electrolyte reaches the eyes, do not rub them. Instead, rinse the eyes with clean running water and immediately seek medical attention. Failure to do this may result in eye injury.
- DO NOT store batteries in a fully charged state for extended periods of time.
  - DO NOT store batteries in a fully discharged state for extended periods of time.
  - DO NOT store batteries in the camera or in a charger for extended periods of time.
  - DO NOT use batteries for purposes other than their intended use.
  - DO NOT store batteries in extreme hot or cold temperatures.
  - DO NOT store batteries in direct sunlight.
  - DO NOT disassemble or modify the battery.
  - DO NOT overcharge batteries. Overcharging may increase internal temperature beyond the recommended limits and cause permanent damage to the battery.
  - DO NOT connect the positive (+) and negative (-) terminals to a metal object such as a wire.
  - DO NOT transport or store the battery together with metal objects such as jewelry, hairpins, etc. as they may generate heat if they come into contact with the battery.
  - DO NOT discard the battery into fire or heat.
  - DO NOT store, use, or recharge the battery near a heat source such as a fire or a heater.
  - DO NOT allow the battery to get wet.
  - DO NOT pierce the battery with pointed or other sharp objects.
  - DO NOT step on, throw, or strike the battery with a hammer.
  - DO NOT use a battery that appears to be deformed or damaged.
  - DO NOT directly solder the battery.

# 1. INTRODUCTION



Figure: V-RAPTOR 8K VV camera

## V-RAPTOR™ 8K VV + 6K S35 (DUAL FORMAT)

V-RAPTOR 8K VV is the latest breakthrough product in RED's long line of innovative image capture technology. The newest entrant into the RED lineup is a compact, all-in-one, and highly powerful cinema camera. It features RED's cinema grade image quality, color science, and sensor technology in a portable form factor cinematographers can take anywhere and adapt to any shooting scenario.

The new sensor in V-RAPTOR 8K VV is an 8K VV plus 6K S35 dual format CMOS sensor. This sensor breaks new technical ground by retaining wide dynamic range and delivering unmatched RED imagery, without compromising creative or technical features. V-RAPTOR 8K VV includes a built-in locking RF-style mount allowing users the flexibility to use the full features of RF-style lenses and several lens adaptors, such as Canon EF, PL, and Leica M mount.

The V-RAPTOR 8K VV records using the R3D format on a CFexpress Type B media card. The RED V-RAPTOR 8K VV is powered by the REDVOLT MICRO-V battery or by a power cable. You can control the V-RAPTOR 8K VV features by using the side **LCD**, or by using RED Control over Wi-Fi or through a wired connection.

### QUICK REFERENCE

Refer to the [Quick Reference](#) section to get familiar with this guide and the camera.



## R3D FILE FORMAT AND REDCODE

All videos and frames are recorded to the R3D® file format. The R3D file format was developed by RED to provide an efficient and manageable RAW video data format that promotes advanced post production editing capabilities. In the R3D file format, the digital image received from the sensor is formatted as a pixel-defect corrected (but in all other aspects unprocessed) 16-bit per pixel RAW data frame. Each RAW frame, or sequence of RAW frames in a clip, is compressed using proprietary REDCODE® RAW compression, then stored to media.

RAW data is recorded independently of any RGB domain color processing such as ISO, White Balance, or other RGB color space settings. Instead, color parameters are saved as reference metadata; that is, color is not burned into the recorded RAW data. This innovative recording technique promotes flexibility in RGB color processing. It allows you to defer color correction to post production, or to adjust the image color in the field, without changing the recorded RAW data image quality or dynamic range.

REDCODE is a compression codec that reduces R3D RAW files down to a manageable size, allowing the media to record longer. The ability to compress RAW data is one of the significant technological advances that RED has brought to the motion picture industry.

## IMAGE PROCESSING PIPELINE

This camera uses RED's Image Processing Pipeline 2 (IPP2). In IPP2, the advanced RED color space (REDWideGamutRGB) allows the camera to use every color that the sensor can generate up to the clipping threshold. Then the camera encodes the image using Log3G10, a gamma curve that retains extreme highlight and shadow detail. Using the advanced color space and gamma curve, RED IPP2 allows you to grade and make color adjustments in post production, instead of in-camera. IPP2 also allows the camera to use a [CDL](#) for grading. For more information about IPP2, refer to the [RED IPP2](#) support page.

## SHOOT FOR VIDEO AND STILLS

High resolution video, such as the digital footage captured by the camera, has surpassed the detail necessary to produce professional full-sized prints. Because of the ability to record at high frame rates and resolution, this camera is ideally suited to capture video and still images, simultaneously.

## POST PRODUCTION

Many non-linear editing systems (NLEs) can open and edit RED footage. Each NLE version may have specific compatibility requirements, such as camera firmware version or camera type. Before shooting, make sure you check all of the compatibility requirements.

You can open and/or edit R3D files by using one of the following products:

- **REDCINE-X PRO:** RED's proprietary application. Download [REDCINE-X PRO for Windows](#) or [REDCINE-X PRO for Mac](#) from [www.red.com/downloads](http://www.red.com/downloads).
- **Adobe Premiere Pro**
- **Avid Media Composer**
- **DaVinci Resolve**
- **Final Cut Pro X:** Requires you to download the [RED Apple Workflow Installer](#) from [www.red.com/downloads](http://www.red.com/downloads).
- **Adobe PhotoShop:** Can open .R3D files, however, you must download the [RED Adobe PhotoShop Installer for Windows](#) or [RED Adobe PhotoShop Installer for Mac](#) from [www.red.com/downloads](http://www.red.com/downloads).
- **Foundry Nuke**
- **Assimilate Scratch**
- **AutoDesk Flame**
- **ColorFront Transkoder** (beta for latest support)

**NOTE:** Third-party applications may have limited compatibility with R3D files. Third-party developers must use the most recent [R3D SDK](#) to offer compatibility with the latest RED firmware.

## POST PRODUCTION WITH REDCINE-X PRO

REDCINE-X PRO is a professional one-light coloring tool set, equipped with an integrated time line, and with a collection of post effects software. REDCINE-X PRO provides the ideal environment to review recorded footage, edit metadata, organize projects, and prepare your R3D files. You can use REDCINE-X PRO or any of the compatible third-party NLEs to edit R3D files.

## ADDITIONAL RESOURCES

- **RED.com:** Visit the [official RED website](#) for the latest information about RED products.
- **RED Downloads:** Go to [RED Downloads](#) to download the latest firmware, operation guides, and post production software.
- **RED 101 Articles:** RED offers [in-depth technical articles](#) about RED cameras, post production, and digital cinematography.
- **RED TECH Videos:** RED offers [videos](#) about understanding and using RED cameras.
- **RED Support:** Visit the [RED SUPPORT site](#) for support articles or to file a support ticket.

## 2. QUICK REFERENCE

Congratulations new RED V-RAPTOR 8K VV camera owner. This quick reference topic helps you get familiar with this guide and the **Camera Body**. It includes links to topics about configuring the camera to fit your recording requirements, and for learning the basic operation of the camera.

### PREPARING THE CAMERA HARDWARE

Prepare the camera hardware for recording by:

- Attaching accessories (refer to **Outrigger Handle**, **V-RAPTOR Wing Grip**, **DSMC3 RED® Touch 7.0" LCD**)
- Installing compatible **Lenses and Adaptors**
- **Inserting Media**
- Connecting a power source (refer to **Power** or **V-RAPTOR 8K VV Power Adaptor**)
- **Turning On the Camera**

### PREPARING THE CAMERA SYSTEM

Configure the camera settings to prepare for recording.

### CONFIGURING THE SETTINGS

- Configuring the camera system settings (refer to the **System Settings Menu**)
- **Upgrading the Firmware**
- Calibrating the camera using the **Calibrate** feature
- Formatting the media (refer to **Secure Format**)
- Specifying the desired recording resolution (refer to **Format**)
- Configuring the **Recording Frame Rate** and **Project Time Base**
- Setting the exposure (refer to **Shutter**)
- Configuring the monitoring tools and reviewing the monitored image (refer to the **Monitoring Menu**)
- Reviewing the camera status (refer to **System Status**)

### RECORDING

Start recording your project.

- Record by pressing the REC button on the **Camera Body** or **Outrigger Handle**
- Record by using an external trigger (refer to **Extension Port**)
- Record by using USB-C (refer to **USB-C Configuration**)
- Record by using Wi-Fi (refer to **How To**)

### PROCESSING FOOTAGE

Perform post-production using any of the standard applications.

- Adobe® Premiere® Pro
- Avid® Media Composer®
- DaVinci Resolve®
- Final Cut Pro X®

## 3. CAMERA COMPONENTS

The camera components include the camera body, battery, lenses and adaptors, media reader, outrigger handle, wing grip, camera LCD, and the RED control app.

### CAMERA BODY

This section describes the **Front**, **Back**, **Left**, **Right**, **Top**, and **Bottom** of the camera, and identifies the controls, buttons, **Camera Body LEDs**, and the lens mount on the body.

### CAMERA BODY CONTROLS AND FEATURES

This section describes the controls and features of the camera.

#### FRONT



Figure: Camera Body Front Controls and Features

#	ITEM	DETAILS
1	Mounting holes	Two upper 1/4"-20 mounting holes
2	Lens release	Press to release RF-type lenses
3	Locking ring	Rotate to lock and unlock lenses
4	REC button	Press to select recording modes or alternate programmable functions
5	Tally light	Indicates that the camera is recording (refer to <b>Camera Body LEDs and Indicators</b> )
6	Mounting holes	Eight lower 1/4"-20 mounting holes

## BACK



Figure: Camera Body Rear Controls and Features

#	ITEM	DETAILS
1	Antenna	Male RP SMA Wi-Fi antenna mounted to a female RP SMA connector. Supports 2.4 GHz and 5 GHz
2	USB-C port	USB-C connection
3	12G-SDI port 1	Full-size 12G-SDI BNC port for SDI monitor connection <sup>1,2</sup>
4	12G-SDI port 2	Full-size 12G-SDI BNC port for SDI monitor connection <sup>1,2</sup>
5	Audio port/LED	5-pin 00B ODU for 2 channel audio (Line, Mic, and +48V)
6	Headphone port	3.5 mm stereo headphone jack
7	DC-IN port	6-pin 1B ODU for DC-IN (11 to 17 Volts) (refer to <b>6-Pin DC-IN</b> )
8	9-Pin <b>Extension Port</b>	9-pin 0B ODU serial port for start/stop, Genlock, TC and RS-232
9	Micro V-Lock port	14.4 V Micro V-Lock battery mount (refer to <b>REDVOLT Micro-V Battery</b> )

1. Use certified 12G-SDI cables.
2. **WARNING:** Always connect the DC power cable (or batteries) before connecting the BNC SDI cable. Always remove the BNC SDI cable before removing the DC power cable (or batteries).



## LEFT

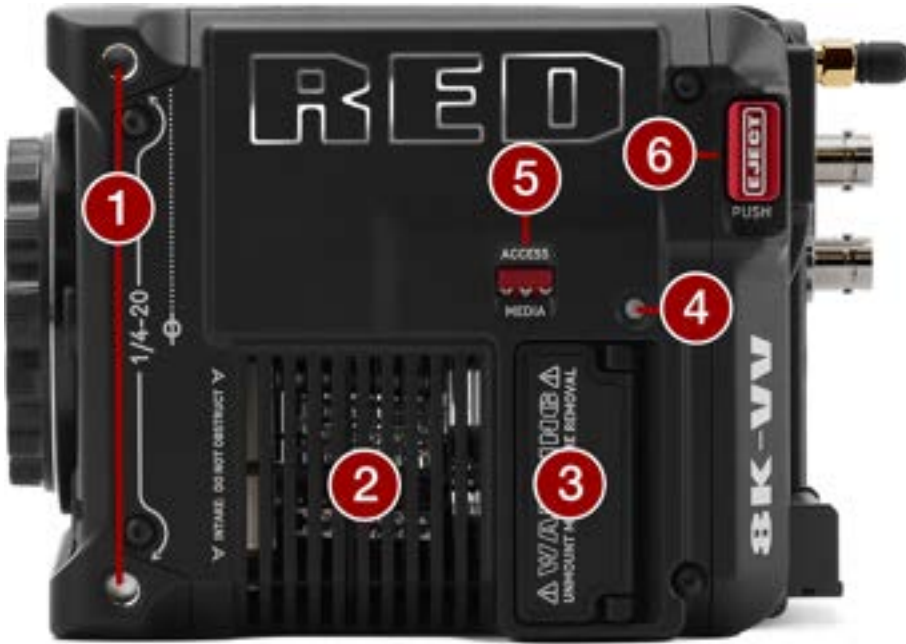

Figure: Camera Body Left Controls and Features

#	ITEM	DETAILS
1	Mounting holes	Two side 1/4-20 mounting holes
2	Intake	Cooling fan air intake
3	Media compartment	Covered CFexpress Type B compartment
4	CFexpress LED	CFexpress status indicator (refer to <a href="#">Camera Body LEDs</a> )
5	Access media	Latch for the CFexpress Type B media compartment door
6	EJECT button	Eject button for Micro V-Lock battery

## RIGHT



Figure: Camera Body Right Controls and Features

#	ITEM	DETAILS
1	Power switch and LED	Slide up to turn on the camera and slide down to turn off the camera. LED displays the camera ready status (refer to <a href="#">Camera Body LEDs</a> )
2	Menu LCD	GUI menu screen and buttons
3	Mounting holes	Two side 1/4"-20 mounting holes
4	Speaker	Beep speaker for audible feedback
5	Record LED	Displays the camera recording status (refer to <a href="#">Camera Body LEDs</a> )
6	REC button	Press and release the <b>REC</b> button to toggle between record start and stop
7	Air intake	Air intake for thermal management
8	Focus plane	Focus plane indicator symbol

TOP



Figure: Camera Body Top Controls and Features

#	ITEM	DETAILS
1	Mounting holes	Four top front 1/4"-20 mounting holes
2	Accessory port	Connection port for accessories (refer to <a href="#">Outrigger Handle</a> , and <a href="#">DSMC3 RED® Touch 7.0" LCD</a> )
3	Exhaust	Air exhaust for thermal management
4	Mounting holes	Eight top side 1/4"-20 mounting holes

**BOTTOM**

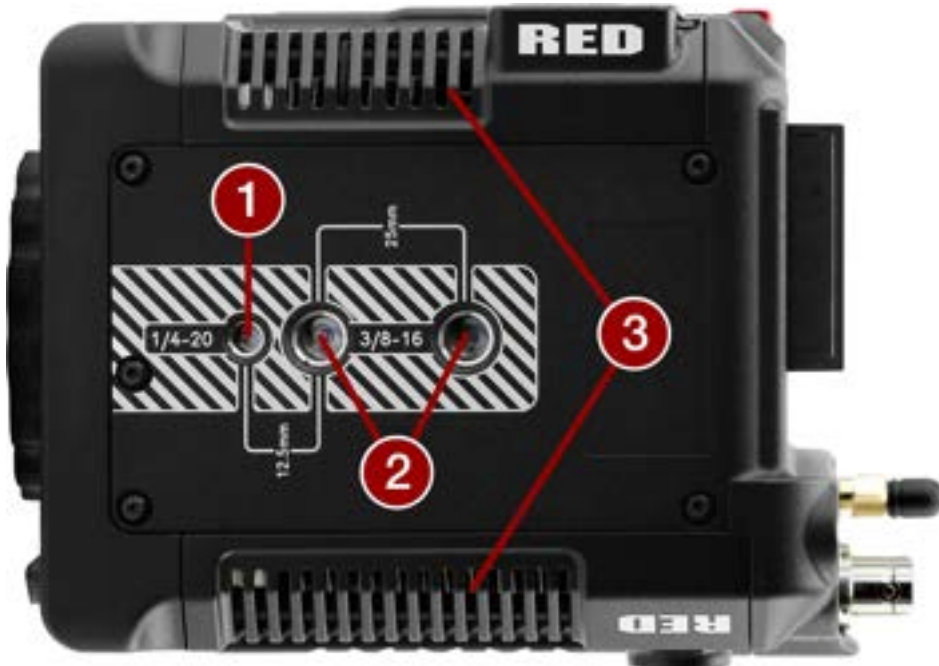

Figure: Camera Body Bottom Features

#	ITEM	DETAILS
1	Mounting point	One (1) 1/4"-20 mounting hole
2	Mounting points	Two (2) 3/8"-16 mounting holes
3	Air intakes	Air intakes for thermal management

## CAMERA BODY LEDS

### FRONT LED



Figure: V-RAPTOR 8K VV LED, Front

#	ITEM	COLOR	DETAILS
1	Tally indicator LED	Red	When enabled, this LED is ON when the camera is recording. For information about enabling this LED, refer to <a href="#">Indicators</a>



## BACK LEDS



Figure: V-RAPTOR 8K VV, DC/Battery LEDs

#	ITEM	COLOR	DETAILS
1	Phantom power	Blue	Indicates that the +48 V Phantom Power is enabled
2	DC-IN	Green	DC-IN is present and / or the battery is fully charged
		Flashing amber	Communicating with, and evaluating, the battery
		Amber	Charging connected battery
		Red	Error charging the battery

## LEFT SIDE LED



Figure: V-RAPTOR 8K VV LED, Left Side

#	ITEM	COLOR/FLASHING	DETAILS
1	CFexpress media LED	Off	No media mounted
		Green	Preview; media mounted with > 10% of media space available
		Amber	Recording finalizing or playback mode
		Amber flashing slow	Formatting media
		Red flashing slow	Media mounted with >5% and <= 10% of media space available
		Red flashing fast	Media mounted with <= 5% of media space available
		Red	Recording with > 10% of media space available

## RIGHT SIDE LEDS



Figure: V-RAPTOR 8K VV LEDs, Right Side

#	ITEM	COLOR/FLASHING	DETAILS
1	Power status (ON)	Off	Camera OFF
		Amber	Camera booting
		Green	Camera ON
		Amber flashing	Camera ON; 5 to 10 min of battery time available
		Red flashing	Camera ON; < 5 min of battery time available
		Red	Camera shutting down
2	Record status (REC)	Off	No media present
		Green	Ready to record
		Red	Recording
		Amber	Finalizing
		Red flashing slow	Media mounted with >5% and <= 10% of media space available
		Red flashing fast	Media mounted with <= 5% of media space available
	Power and record	Both flashing green	Firmware update in progress
		Both flashing red	Firmware update error (refer to <a href="#">Upgrading the Firmware</a> )

## REDOVOLT MICRO-V BATTERY

The camera uses the REDVOLT Micro-V 14.7 V battery. This battery includes an LED charge level indicator, a P-Tap port, and a USB power port.



ITEM	DETAILS
Type	Rechargeable Lithium-Ion Battery
Capacity	6600 mAh / 98 Wh
Battery output	14.8 V DC
P-Tap output	12 V DC
USB output	5 V DC (3 Amps)
Maximum load	12 Amps at 14 V DC
Operating temperature	50° F ~ 113° F (10° C ~ 45° C)
Charging temperature	32° F ~ 104° F (0° C ~ 40° C)
Storage temperature	68° F ~ 122° F (20° C ~ 50° C)
Charger	RED Compact Dual V-Lock charger
Weight	Approximately 1.2 lb (544.3 g)
Dimensions	Height: 3.93 in. (99.8 mm)
	Width: 2.82 in. (71.6 mm)
	Depth: 1.94 in. (49.3 mm)

The camera charges the battery when the camera is off and a power cable is connected. You can also use the optional RED Compact Dual V-Lock charger.

## RED COMPACT DUAL V-LOCK CHARGER

The optional RED Compact Dual V-Lock charger allows you to charge two REDVOLT Micro-V batteries.



ITEM	DETAILS
Input	100 V - 240 V AC 50 Hz to 60 Hz
Charge current	One battery 3 Amps, two batteries 1.5 Amps
Charging temperature	32° F ~ 104° F (0° C ~ 40° C)
Storage temperature	68° F ~ 122° F (20° C ~ 50° C)
Battery compatibility	REDVOLT Micro-V 14.7 V DC
Weight	Approximately 1 lb (453.5 g)
Dimensions	Height: 4.5 in. (114.3 mm)
	Width: 5.5 in. (139.7 mm)
	Depth: 3 in. (76.2 mm)

## COMPATIBLE BATTERIES

Compatible batteries are those that provide enough current (14.4 V with 8 A or greater) to power the RED V-RAPTOR, and that also fit the dimensions on the V-RAPTOR's integrated Micro V-Lock plate.

RED chose the Micro V-Lock plate for the V-RAPTOR to keep its form-factor compact. As a result, not all V-Lock batteries are compatible with the camera.

### NOTE:

- V-Lock batteries with a width greater than 2.95 in. (75 mm) are not compatible with the camera's Micro V-Lock plate and will require adapter plates.
- The camera can charge a battery that supports SMBus communication directly. To charge the battery, the camera must be powered off while connected to DC-IN power.



## LENSES AND ADAPTORS

This section lists the compatible lenses and adaptors for the camera. It also provides the steps for [Attaching Lenses](#) and [Removing Lenses](#).

For more information on a specific lens or adaptor, refer to the original manufacturer's instructions.

**WARNING:** When the camera is not in use, protect lenses and the camera sensor by attaching the lens caps and camera mount cap.



*Figure: Camera with mount cap installed.*

Incompatible lenses do not register on the camera UI and they will not show any UI lens information or menu controls. The camera can control compatible lenses electronically, including the following features:

- Iris - The UI menu is enabled and the camera can control the lens Iris
- Autofocus - The UI menu is enabled for lenses that support autofocus
- Image Stabilization - The UI indicates that image stabilization is present
- Control Ring - The UI menu is enabled and the camera can use the control ring

For more information, refer to the [Lens](#) menu.

## COMPATIBLE LENSES

The latest RED-tested and approved lenses are listed on the V-RAPTOR 8K VV section of [RED Support](#).

## LENS WEIGHT AND LENS SUPPORT

Use a lens support system when mounting heavy or long lenses to your camera.

When mounting a heavy or long lens, ensure that the full weight of the lens is never directly on the camera or lens mount. Mount the lens to the support system first, and then carefully mount the lens to the camera.

## COMPATIBLE MOUNT ADAPTORS

RED tested the following adaptors and determined that they are compatible with the camera:

- Canon Mount Adaptor EF-EOS R
- Canon Drop-In Filter Mount Adaptor EF-EOS R with Variable ND Filter / Clear Filter / Circular Polarizer

Refer to the V-RAPTOR 8K VV section of [RED Support](#) for more information.

## ATTACHING LENSES

1. Unlock the locking ring by rotating it to the fully counterclockwise position.
2. Press and hold the lens release button on the camera. While holding the lens release button, turn the camera lens mount cap counter-clockwise until it stops, and remove it from the camera. If the lens locking ring rotates while removing the cap, make sure that you hold the locking ring tab in place while rotating the cap.
3. Remove the rear lens cap from the mount end of the lens.
4. Align the red dot on the lens mount with the red dot on the camera lens mount, and insert the lens mount of the lens in the camera lens mount opening.
5. Turn the lens clockwise until it clicks in place. If the lens locking ring rotates while attaching the lens, make sure that you hold the locking ring tab in place while rotating the lens or adaptor.
6. Gently tighten the locking ring. **DO NOT OVER-TIGHTEN THE LOCKING RING.**
7. Store the camera lens mount cap and the rear lens cap together in a dust free location.

## REMOVING LENSES

1. Loosen the locking ring gently.
2. Press and hold the lens release button on the camera. While holding the lens release button, turn the lens counterclockwise until it stops, and remove it from the camera. If the lens locking ring rotates while removing the lens, make sure that you hold the locking ring tab in place while rotating the lens or adaptor.
3. Align the red dot on the camera lens mount cap with the red dot on the camera lens mount, and attach the cap to the camera.
4. Gently tighten the locking ring. **DO NOT OVER-TIGHTEN THE LOCKING RING.**
5. Attach the rear lens cap to the lens.
6. Store the lens with the front and rear caps attached.

## RED CFEXPRESS TYPE B MEDIA



The RED CFexpress Type B Media provides the camera with a 660 gigabyte recording option.

ITEM	DETAILS
Type	CFexpress Type B Media
Capacity	660,138,909,696 bytes
Operating temperature	14° F to 158° F (-10° C to 70° C)
Operating humidity	5% to 95%, non-condensing
Storage temperature	-4° F to 185° F (-20° C to 85° C)
Shock resistance (operating)	50 g
Vibration resistance (operating)	15 g at 10 Hz to 2000 Hz
Weight	Approximately 0.25 oz (7.1 g)
Dimensions	Height: 1.52 in. (38.5 mm)
	Width: 1.17 in. (29.6 mm)
	Depth: 0.15 in. (3.8 mm)

## RED CFEXPRESS TYPE B READER

The RED CFexpress Type B Card Reader provides a fast USB-C connection with the capability of write-protect.

Set the Write-Protect switch to the Lock position to prevent connected devices from adding any unwanted data to your CFexpress Type B card.



ITEM	DETAILS
Media read	CFexpress Type B
Interface	USB-C 3.2 cable to CFexpress Type B
Power	USB bus power
Cable	USB-C 3.2 cable type A to C adapter
Weight	Approximately 4.2 oz (120 g)
Dimensions	Height: 3.74 in. (95 mm)
	Width: 2.56 in. (65 mm)
	Depth: 0.47 in. (12 mm)

## OUTRIGGER HANDLE

The Outrigger Handle offers a low profile, 360° adjustable ergonomic pistol grip and integrated Record Start/Stop button. Mounted to the Top Handle Port on your camera, the Outrigger Handle provides comfort, stability, and additional 1/4-20 mounting points for your peripheral camera components. The built-in Record button puts Start/Stop functionality right at your fingertips. You are always ready to capture the perfect shot.



The Outrigger Handle is ideal for shooters who use one hand on the handle for grip and record button access, and the other for lens adjustments or support.

## V-RAPTOR WING GRIP

The V-RAPTOR Wing Grip offers comfort and utility for carrying or shooting with your V-RAPTOR 8K VV.



Featuring an ergonomic machined grip with tactical 1/4"-20, 3/8"-16, and M4 mounting points. It is lightweight and offers a seamless low-profile hand-held option.

## DSMC3 RED® TOUCH 7.0" LCD

The optional DSMC3 RED® Touch 7.0" LCD offers an HD viewing experience for recording and viewing footage on the V-RAPTOR 8K VV camera system. A 1920 x 1200 resolution display panel with peak brightness of 1300 nits and high pixel density (at 322 ppi), not only provides the optimal experience when viewing footage, but also features 100% DCI-P3 color gamut coverage for tremendous color accuracy.

This monitor also features full control over the camera through the new responsive menu system powered by SmallHD PageOS. The features include Waveform, Vectorscope, Histogram, False Color, Color Picker, Pixel Zoom, and more.

The lightweight display mounts to a removable integrated tilt arm with the capability to rotate 180 degrees for versatile mounting options. It also boasts the latest generation pogo pins to provide power and video to the monitor, and the ability to connect through a single-locking USB-C-style DSMC3 RMI cable for video and power. No additional SDI or power cables are needed. Refer to [RED Monitor Interface Cable](#) for more information.

**NOTE:** The USB-C-style DSMC3 RMI cable is not a standard USB-C cable. The DSMC3 RED Touch 7.0" LCD is not compatible with DSMC®, DSMC2®, RED RANGER® or KOMODO® camera systems.

For more information, refer to the [DSMC3 RED® Touch 7.0" LCD User Guide](#).



### SPECIFICATIONS

ITEM	DETAILS
Material	Aluminum alloy

# V-RAPTOR™ 8K VV OPERATION GUIDE

<b>ITEM</b>	<b>DETAILS</b>
Resolution	1920 x 1200
Pixel density	322 ppi
Refresh rate	60 Hz
Response time	25 ms
Contrast	1250:1
Brightness	1300 cd/m2
Color depth	10 bit
Colors	100% DCI-P3
Viewing angle	± 160° all axes
Display orientation	Landscape, 180° rotation
Touch	pCap Multi-Touch
Camera connection	Power and communication through the RMI cable
Mounting	15 mm rail
Hood Mounting	4 x M3 mounting points
Buttons	4 buttons function 1, 2, 3 & 4
Power consumption	15.5 Watts
Operating temperature	32° F to 104° F (0° C to 38° C)
Storage temperature	-0° F to 120° F (-18° C to 49° C)
Operating humidity	0% to 85%, non-condensing
Storage humidity	0% to 85%, non-condensing
Firmware requirement	Compatible with V-RAPTOR firmware version 1.1 or later
Monitor dimensions	Weight approximately 1.25 lb (568.0 g) Height: 4.67 in. (118.70 mm) Width: 7.09 in. (180.10 mm) Depth: 1.13 in. (28.80 mm)
Arm dimensions	Weight approximately 0.07 lb (30.1 g) Height: 1.18 in. (30.00 mm) Width: 2.40 in. (61.00 mm) Depth: 0.70 in. (17.50 mm)
RED Monitor Interface (RMI) dimensions	Weight approximately 0.28 lbs (126 g) Height: 1.67 in. (42.50 mm) Width: 4.25 in. (108.00 mm) Depth: 1.51 in. (38.23 mm)



## LCD



This section describes the graphical user interface (GUI) for the built-in camera side LCD. Durable controls enable convenient access to menus, camera features, and critical camera information.

## LCD NAVIGATION

Press the up and down arrows together to lock or unlock the LCD. When the LCD is locked, the Lock icon displays briefly whenever you push an LCD button.

Select items on the LCD screen by pressing the adjacent buttons:



In this example, pressing the button above FPS opens the Recording Frame Rate selection list:



Press the up and down arrows to navigate the list. Press the button below OK or press the SEL button to accept the choice and return to the Home Page. Press the button below CANCEL or press the MENU button to return to the Home Page without making a change. Press the button under EDIT to open a manual editing screen.

## MENUS

Press the MENU button from the Home Page to open the Menus:



Press the up and down arrows to navigate up and down in the menu list. Press SEL to select a menu and open the submenus:



Press SEL to select a submenu and open a list of menu items:



Press the buttons above FIRST, LAST, PAGE▲, or PAGE▼ or press the up or down arrow to navigate the list. Press SEL, or the button under OK, to select the item. Press MENU, or the button under CANCEL, to return to the menu without making a selection.

For more information about menus, refer to [Menus](#).

## PAGES

The LCD contains the Home Page, Histogram Page, Tools Page, SDI Page, Audio Channels 1 and 2 Page, Audio Channels 3 and 4 Page, Headphones Page, and User Pages 1, 2, and 3.

Press the up arrow or down arrow to navigate through the pages. Select the pages you want the LCD to display by using the Side LCD menu (refer to [Side LCD Control Panels](#)).

## HOME PAGE

The Home Page contains the Recording Quick Settings, Exposure Meter, Recording Status, VU Meter, Status Bar, and Quick Menu (refer to [Home Page](#)).



## HISTOGRAM PAGE

The Histogram Page contains the Autofocus Quick Settings, Exposure Meter, Histogram, and Lens Quick Settings (refer to [Histogram Page](#)).

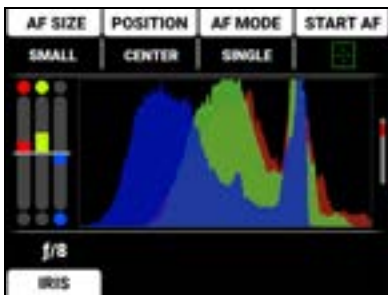

## TOOLS PAGE

The Tools Page contains the Peaking Tools, Exposure Tools, Zebra Tools, and Quick Monitor Menu (refer to [Tools Page](#)).



## SDI PAGE

The SDI Page contains the switches you use to enable or disable the SDI features, and the Look settings for SDI Port 1 and SDI Port 2 (refer to [SDI Page](#)).



## AUDIO CHANNELS 1 / 2 PAGE

The Audio Channels 1 / 2 Page contains the settings for the internal microphone channels 1 and 2 (refer to [Audio Channels 1 and 2 Page](#)).

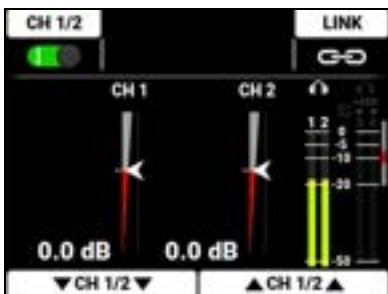

## AUDIO CHANNELS 3 / 4 PAGE

The Audio Channels 3 / 4 Page contains the settings for the external audio port channels 3 and 4 (refer to [Audio Channels 3 / 4 Page](#)).

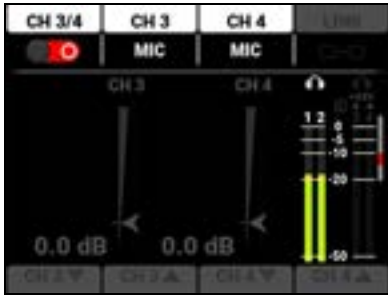

## HEADPHONE PAGE

The Headphone Page contains the settings for the headphone port audio output (refer to [Headphone Page](#)).



## USER PAGES

The User Pages (1-3) allow you to assign eight quick buttons to each page (refer to [User Pages](#)).



## HOME PAGE



This section describes the Home Page of the LCD GUI. This page contains the Quick Settings, Exposure Meter, Recording Information, VU Meter, Status Bar, and Quick Menu. This is the first page that displays when you power up the camera.

## RECORDING QUICK SETTINGS

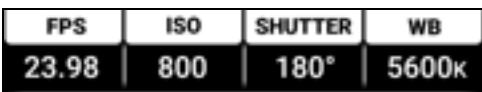

The Recording Quick Settings section of the LCD home page displays the Recording Quick Settings buttons. You can use these buttons to quickly access the most often used camera recording menu settings. These settings include [Recording Frame Rate](#), [ISO](#), [Shutter](#), and [White Balance](#).



Press the top buttons to open the menu item lists.

Press Up and Down to navigate the list.

Press the button under OK or SEL to select the item and return to the Home Page.

Press the button under CANCEL or press MENU to return to the Home Page without making any changes.

Press and hold the button above SHUTTER to toggle the shutter between degrees and fractions (refer to [Shutter](#) for more information).

Press and hold White Balance (WB) to toggle between Color Temperature and Color Temperature Presets (refer to [White Balance](#) for more information).

## EXPOSURE

The Exposure section of the LCD home page displays the RGB exposure levels for the camera.

### Exposure Meter

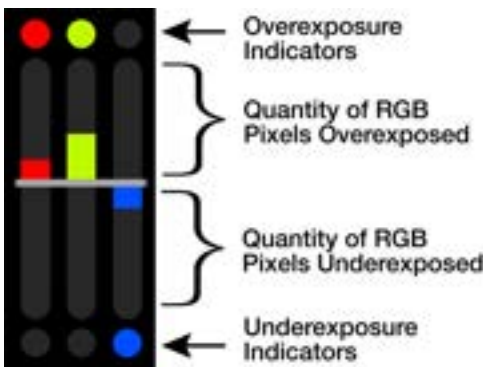

### Overexposed Example

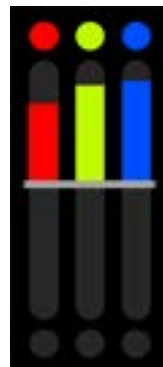

### Underexposed Example



### Balanced Example

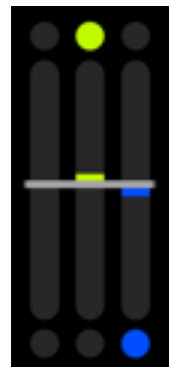

RGB Exposure Meter displays the quantity of over or under exposed pixels in each of the separate red, green, and blue channels.

The top and bottom RGB lights illuminate when a small amount of pixels on the sensor are overexposed or underexposed. This indicates that a small number of pixels in the image are too bright and will not contain any detail, or are too dark and will appear as noise.

The bars show the quantity of overexposed and underexposed RGB pixels on the sensor. Adjust the settings in the camera such as Iris, or shutter speed to compensate, or change the scene's lighting for the best balanced image.

## CAMERA DESIGNATION AND REC INDICATOR



The Camera Designation and Record indicator on the LCD home page displays the camera letter assigned to the camera (refer to [Slate](#) and [Camera ID](#)). The color of this area indicates when the camera recording is ready (black), when the camera is recording (red), and when the recording is stopped and the camera is adding the pre-recording (yellow).

Recording:



Adding Pre-Recording:



## TIMECODE / EDGE CODE

The Timecode / Edgecode section displays the timecode or edgecode (refer to [Timecode Display Mode](#)).

Timecode:



Edgecode:



This text turns red when the camera is recording.



## CLIP

The Clip area displays the clip name designated in the Project Settings menu (refer to [Slate](#)).



## DURATION

The Duration area displays the real-time duration of the current clip.



## SENSOR FORMAT

The Sensor Format area displays the sensor format selected in the Project Settings (refer to [Format](#)).



## QUALITY

The Quality area displays the R3D compression level (refer to [R3D Quality](#)).



## PROJECT TIME BASE

The Project Time Base area displays the playback rate for the recorded footage selected in the Project Settings (refer to [Project Time Base](#)).



## 3D LUT

The 3D LUT area displays the LUT file selected in the Image / LUT menu (refer to [3D LUT](#)).



## STATUS BAR



The [Status Bar](#) contains status icons for various camera settings and inputs.

## QUICK MENUS



The Quick Menu section of the LCD home page displays the Quick Menu buttons. You can use these buttons to quickly access the most often used camera menus. These settings include [Project Settings Menu](#), [Media Menu](#), [Monitoring Menu](#), and [Playback](#).

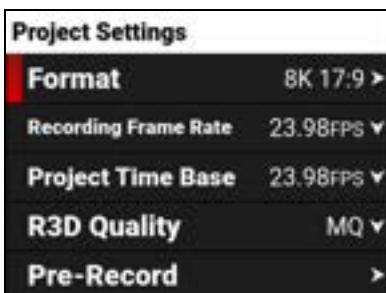

Press the bottom buttons to open the Quick Menu.

Press Up, Down, and SEL to navigate the menus.

Press MENU to return to the Home screen.

## HISTOGRAM PAGE

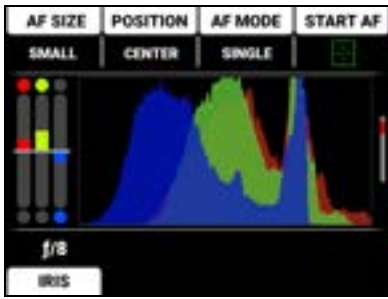

The LCD Histogram page is the second page on the LCD. Press the down button to navigate from the Home page to the Histogram page.

The Histogram Page contains the Autofocus Quick Settings, Exposure Meter, Histogram, and Lens Quick Settings.

## AUTOFOCUS QUICK SETTINGS

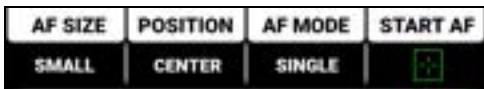

The Autofocus quick settings allow you to access the Autofocus settings quickly.

- Press the button above AF SIZE to select the autofocus size



- Press the button above POSITION to select the autofocus location on the screen



- Press the button above AF MODE to select the autofocus mode



- Press the button above START AF to enable autofocus

Refer to [Autofocus - BETA Menu](#) for more information about the Autofocus menu.

## EXPOSURE METER

The Exposure meter displays the RGB exposure levels for the camera.

### Exposure Meter

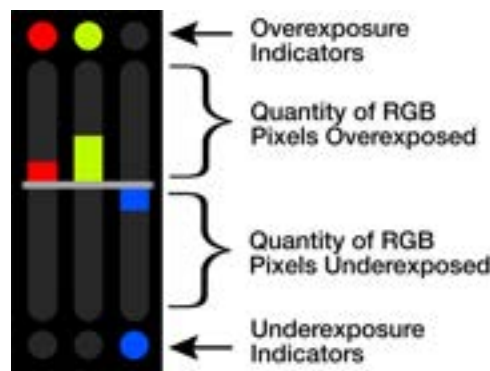

### Overexposed Example

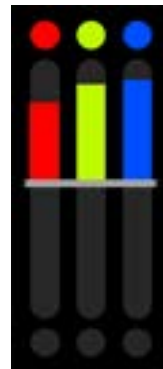

### Underexposed Example



### Balanced Example



RGB Exposure Meter displays the quantity of over or under exposed pixels in each of the separate red, green, and blue channels.

The top and bottom RGB lights illuminate when a small amount of pixels on the sensor are overexposed or underexposed. This indicates that a small number of pixels in the image are too bright and will not contain any detail, or are too dark and will appear as noise.

The bars show the quantity of overexposed and underexposed RGB pixels on the sensor. Adjust the settings in the camera such as Iris, or shutter speed to compensate, or change the scene's lighting for the best balanced image.

## HISTOGRAM

The Histogram area displays a histogram distribution of the RGB exposure of the Log3G10 signal after ISO and White Balance adjustments.

The histogram displays the darkest image elements at the far left, the midtones in the middle, and the lightest image elements at the far right. This gives you a fast way to determine your overall image exposure levels.

### Overexposed Example

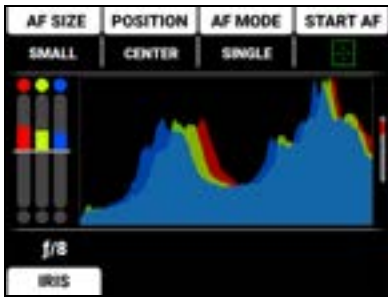

### Underexposed Example

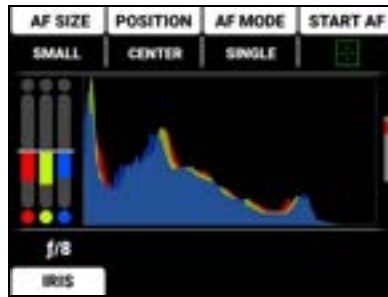

## LENS QUICK SETTINGS



The Lens quick settings allow you to access the Iris settings quickly.

Press the button under IRIS to open the Iris menu list and select the lens f-stop.

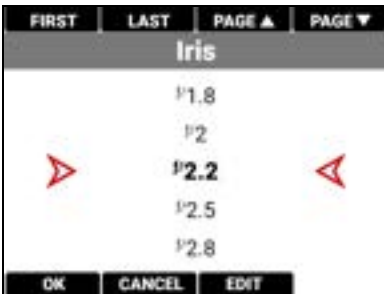

Refer to [Lens](#) for more information about the Iris settings.

## TOOLS PAGE



The LCD Tools page is the third page on the LCD. Press the down button twice to navigate from the Home page to the Tools page.

The Tools Page contains the Peaking Modes, False Color Modes, Zebra Tool Switches, and Quick Monitor Menu.

## PEAKING MODES



The Peaking tools are modes that provide different ways to indicate image focus. The Peaking modes you can select include:

ITEM	DETAILS
Peaking	Select a colored overlay to indicate objects in focus
Edge	Show outlines of focused objects
Focus	Use enhanced contrast and edges for focusing

Press the button below the Peaking tools column to cycle through the choices. When you select the Peaking tool Peaking mode, the settings for Color and Level are enabled:



For more information refer to [Peaking](#).

## FALSE COLOR MODES



Press the button below the False Color tools column to cycle through the choices.

False Color Modes include:

ITEM	DETAILS
False Color Video Mode	Access scene exposure in varying light without relying on the LCD image brightness.
False Color Exposure Mode	Use false colors to determine an optimal balance between overexposure and underexposure.

**NOTE:** False Color modes display on video recorded through SDI to an external recorder when the Tools are enabled in the Monitor menu. When recording through SDI, use False Color modes only to help determine scene exposure settings, and then disable the mode before recording.

## FALSE COLOR VIDEO MODE

**NOTE:** For best results, Video Mode should be viewed at or above ISO 800.

Video Mode displays a color overlay that indicates the video level of the RGB monitor path (calibrated to the SMPTE test signal).

The colors used are based on the RGB levels of the video out signal (that is, the “cooked” look, and not RAW data). The camera's RGB settings can change the appearance of the Video Mode colors.

For more information, refer to [False Color](#).

## FALSE COLOR EXPOSURE MODE

When this monitoring False Color mode is activated, most of the tonal range will appear in monochrome.

The Exposure Mode is able to indicate exactly where middle gray is falling, and indicate which highlights or shadows are problematic in the logarithmic representation of the image. Exposure mode is judging the exposure after ISO and White Balance adjustments are made, and before any sort of LUT or transform is applied to the Log3G10 image.

For more information, refer to [False Color](#).

## ZEBRA TOOLS

Use Zebra 1 to display one set of diagonal stripes to indicate highlight exposure levels. Use Zebra 2 to display a second set of diagonal stripes to indicate mid-tone and shadow levels. For more information, refer to [Zebra Modes](#).



## ZEBRA 1



Press the button below the ZEBRA 1 switch to enable or disable the Zebra 1 tool.

For more information, refer to [Zebra 1](#).

## ZEBRA 2



Press the button below the ZEBRA 2 switch to enable or disable the Zebra 2 tool.

For more information, refer to [Zebra 2](#).

## QUICK MONITOR MENU



Press the button above SETTINGS to open the Quick Monitoring Menu.



For more information, refer to [Monitoring Menu](#).

## SDI PAGE



The SDI Page contains the switches you use to enable or disable the SDI features, and the Look settings for SDI Port 1 and SDI Port 2.

## SWITCHES

The SDI 1 and SDI 2 sections contain the switches you can use to enable and disable image magnification, focus and exposure tools, and frame and center guides. For more information, refer to the [Monitoring Menu](#) section.

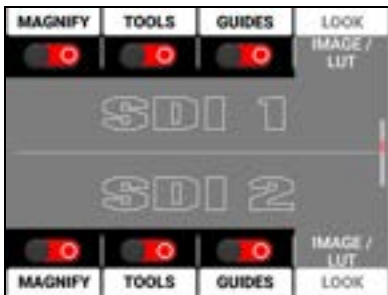

Press the button next to the switch to toggle from disabled to enabled.

Select LOOK to open the Look options for the SDI 1 and SDI 2 ports.

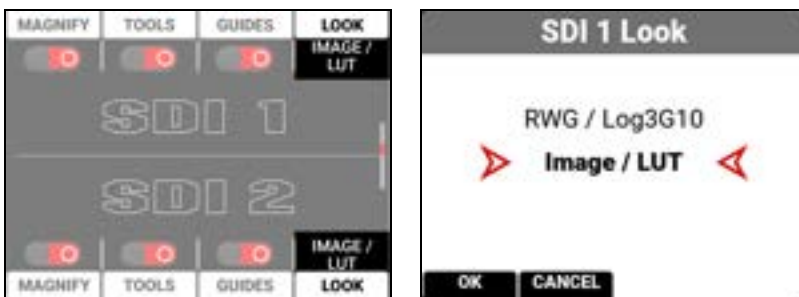

You can select the Image / LUT look defined in the Image / LUT menu, or you can select the RWG (REDWideGamutRGB) / Log3G10 Image Processing Pipeline (IPP2) look.

## AUDIO CHANNELS 1 AND 2 PAGE

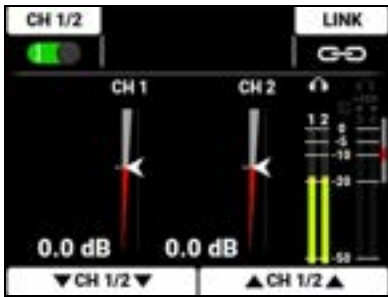

Press the down button to navigate from the Home page to the Audio Channels 1 and 2 page.

The Audio Channels 1 and 2 page contains the switch to enable the internal microphone channels (1 and 2), a button to enable and disable the link between the channel 1 and 2 levels, the audio level indicators, the headphone monitoring indicator, the 48 volt phantom power indicator, the audio VU meters for channels 1, 2, 3, and 4, adjusters to reduce the audio channel 1 and 2 levels, and adjusters to increase the audio channel 1 and 2 levels.

## TOP BAR



The Audio Channels 1 and 2 top bar allows you to enable the internal microphones (channels 1 and 2).

- Press the button above CH 1/2 to enable or disable the internal microphones
- Press the button above LINK to link the audio level adjustments for channels 1 and 2

Refer to the [Audio / TC Menu](#) section for more information about the audio features.

## LEVEL INDICATORS

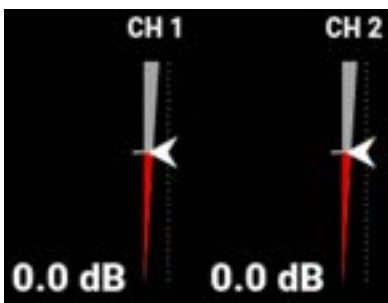

The audio level indicators move up and down to indicate the changes in the audio level adjustments. The level measured in decibels is displayed below the level indicators. You can adjust channels 1 and 2 individually, or you can link the channels and adjust them together.

## VU METER

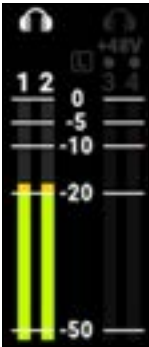

The VU meter displays the headphone indicators, the limiter indicator, the 48 V phantom power indicator, the audio channel numbers, and the audio signal levels.

## BOTTOM BAR



The Audio Channels 1 and 2 bottom bar allows you to adjust the internal microphones (channels 1 and 2). You can adjust the channels individually or you can link them and adjust them together.

- Press the buttons below CH1▼ to reduce the external audio levels (channel 1)
- Press the buttons below CH1▲ to increase the external audio levels (channel 1)
- Press the buttons below CH 2▼ to reduce the external audio levels (channel 2)
- Press the buttons below CH 2▲ to increase the external audio levels (channel 2)

Refer to the [Audio / TC Menu](#) section for more information about the audio features.

## AUDIO CHANNELS 3 / 4 PAGE

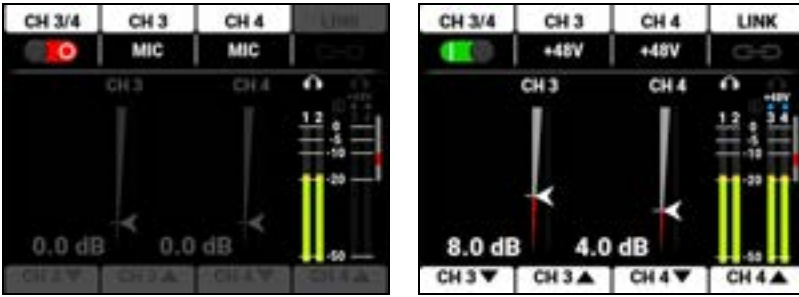

Press the down button to navigate from the Home page to the Audio Channels 3 and 4 page.

The Audio Channels 3 and 4 page contains a switch to enable the external audio input channels (3 and 4), a button to enable and disable the link between the channel 3 and 4 levels, the audio level indicators, the headphone monitoring indicator, the 48 volt phantom power indicator, the audio VU meters for channels 1, 2, 3, and 4, adjusters to reduce the audio channel 3 and 4 levels, and adjusters to increase the audio channel 3 and 4 levels.

## TOP BAR



The Audio Channels 3 and 4 top bar allows you to enable the external audio inputs (channels 3 and 4).

- Press the button above CH 3/4 to enable or disable the external audio
- Press the button above CH 3 or CH 4 to open a list of external audio options for those channels (Mic, Line, +48V)



- Press the button above LINK to link the audio level adjustments for channels 3 and 4

Refer to the [Audio / TC Menu](#) section for more information about the audio features.

## LEVEL INDICATORS

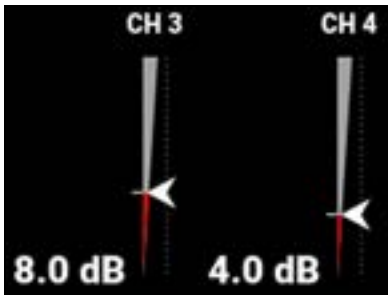

The audio level indicators move up and down to indicate the changes in the audio level adjustments. The level measured in decibels is displayed below the level indicators. You can adjust channels 3 and 4 individually, or you can link the channels and adjust them together.

## VU METER

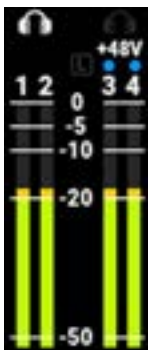

The VU meter displays the headphone indicators, the limiter indicator, the +48 V phantom power indicator, the audio channel numbers, and the audio signal levels.

## BOTTOM BAR



The Audio Channels 3 and 4 bottom bar allows you to adjust the external audio (channels 3 and 4). You can adjust the channels individually or you can link them and adjust them together.

- Press the buttons below CH 3▼ to reduce the external audio levels (channel 3)
- Press the buttons below CH 3▲ to increase the external audio levels (channel 3)
- Press the buttons below CH 4▼ to reduce the external audio levels (channel 4)
- Press the buttons below CH 4▲ to increase the external audio levels (channel 4)

Refer to the [Audio / TC Menu](#) section for more information about the audio features.

## HEADPHONE PAGE

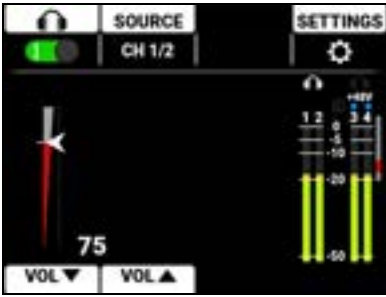

Press the down button to navigate from the Home page to the Headphone page.

The Headphone page contains the switch to enable the headphone jack, a source list to select the source to monitor (CH 1/2 or CH 3/4), the headphone level indicator, the headphone monitoring indicator, the limiter indicator, the +48 volt phantom power indicator, the audio VU meters for channels 1, 2, 3, and 4, an adjuster to reduce the headphone levels, and an adjuster to increase the headphone levels.

## TOP BAR



The Headphone top bar allows you to enable/disable the headphone port output, to select the source of the headphone output (internal channels 1 and 2 or external channels 3 and 4), and to quickly access the Audio /TC menu.

- Press the button above the headphone icon to enable or disable the headphone audio
- Press the button above SOURCE to open the list of channels to monitor (Ch 1/2 or Ch 3/4)

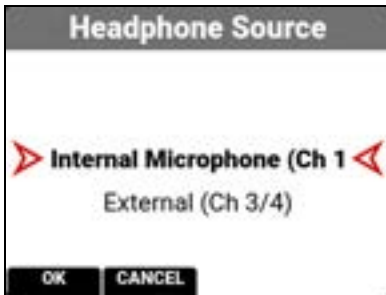

- Press the button above SETTINGS to open the Audio / TC menu

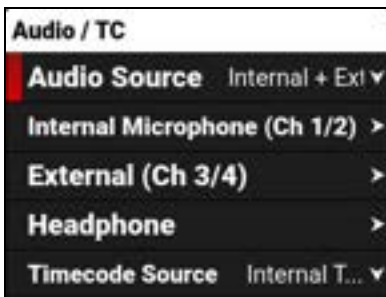

Refer to the [Audio / TC Menu](#) section for more information about the audio features.



## LEVEL INDICATOR



The audio level indicator moves up and down to indicate the changes in the headphone level adjustments. The level measured in decibels is displayed below the level indicator.

## VU METER

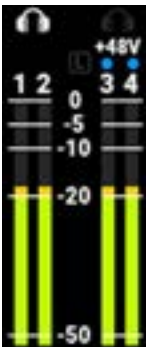

The VU meter displays the headphone indicators, the limiter indicator, the +48 V phantom power indicator, the audio channel numbers, and the audio signal levels.

## BOTTOM BAR



The headphone bottom bar allows you to adjust the headphone volume.

- Press the button below VOL▼ to reduce the headphone volume
- Press the button below VOL▲ to increase the headphone volume

Refer to the [Audio / TC Menu](#) section for more information about the headphone features.

## USER PAGES

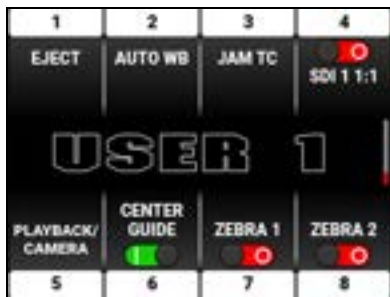

The User (1, 2, 3) pages are the last pages on the LCD. Press the up button to navigate from the Home page to the User pages.

The User Pages contain the settings you assigned to the pages in the User Settings menu. From this page you can press buttons next to 1-8 to quickly select a camera setting or feature.

Refer to the [User Settings Menu](#) section for more information.

## PLAYBACK

When you press the button below PLAY on the Home Page, the LCD displays the Playback screen.



To close the Playback screen, press the button below CAMERA.

## PLAYBACK SCREEN



The Playback screen displays the following:

- [Clip Information](#)
- [Playback Screen Buttons](#)

## CLIP INFORMATION



The Clip Information displays the name, Timecode, duration, project time base, format, and timeline of the clip.

## PLAYBACK SCREEN BUTTONS



With the Playback screen buttons you can view the Clip list, move to the start of the clip, fast reverse, play/pause, fast forward, and move forward and reverse by a single frame.

## CLIP LIST



Press the button over the Clip List to open the Clip Load list.

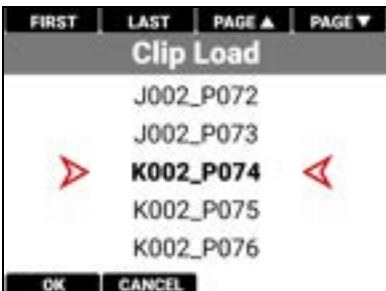

Navigate to the desired clip and press the button under OK to open the clip in the Playback screen.

## START/END



Press the button above the Start or End button to navigate to the start or end of the clip.

## NEXT PREVIOUS



Press the UP arrow to move forward by a single frame and press the DOWN arrow to reverse by a single frame.

## REWIND



Press the button below Rewind to quickly navigate backwards through the clip.

## PLAY/PAUSE



Press the button below Play/Pause to toggle between playing the clip and pausing the clip.

## FAST FORWARD



Press the button below Fast Forward to quickly navigate forward through the clip.

## CAMERA



Press the button below CAMERA to return to the camera interface.

## RED CONTROL APP

The RED Control app provides remote and tethered access to the camera from a device. Access is available through Wi-Fi, USB-C, and Ethernet.

The RED Control app is free through the Google Play store and the Apple App store.

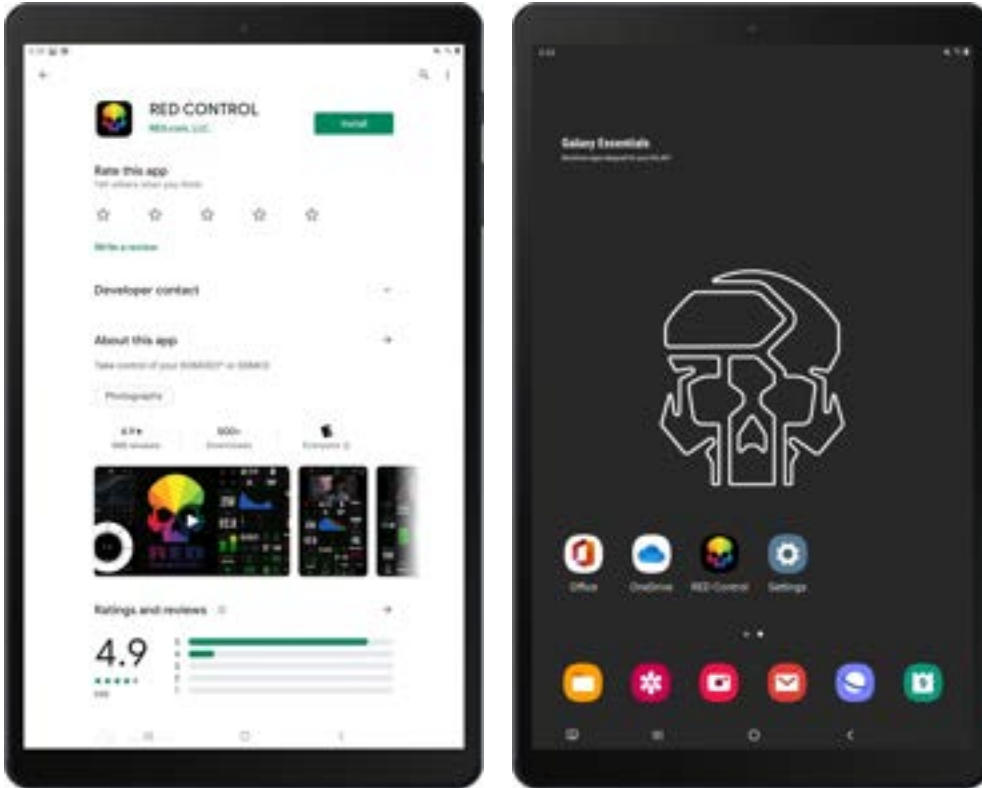

The RED Control app allows you to control all of the camera features while viewing the image.

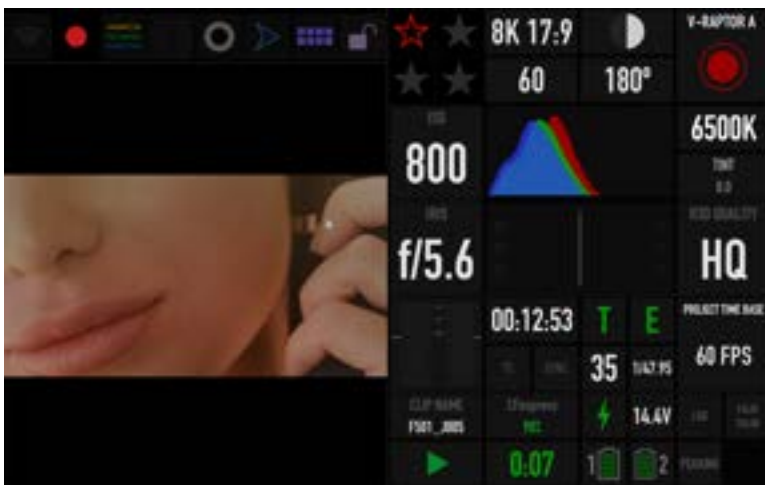













For more information about connecting the camera to RED Control, refer to the How To section ([USB-C Configuration](#)).

## STATUS BAR

The LCD screen displays the camera status bar.



The Status Bar contains the following button and icons:

-  CFexpress Status Icon
-  Temperature / Exposure Icon
-  Timecode Icon
-  Genlock Icon
-  SYNC Icon
-  Camera Status Icon
-  FTPS Activity Icon
-  Wi-Fi Icon
-  Network Icon
-  LCD Lock Icon
-  Battery Icon
-  DC-In Icon

### CFEXPRESS STATUS ICON



This icon displays the status of the CFexpress media card, and it displays the recording time remaining for the current camera settings.

The status displayed includes:



Good



Missing



Incompatible

### TEMPERATURE / EXPOSURE ICON



This icon displays the temperature (T) and exposure (E) calibration indicators.

- When T is yellow or red, it indicates that the camera requires sensor re-calibration.
- When E is yellow or red, it indicates that the camera requires sensor re-calibration.

Refer to [Calibrating the Sensor](#).

---

## TIMECODE ICON

---



This icon indicates the state of the Timecode generator connection.



Gray indicates that no Timecode generator signal is detected.



Green indicates that the Timecode source is connected and jammed.



Red indicates that the Timecode source is connected and not jammed.



White indicates that the Timecode source is jammed and not connected.



Yellow indicates that the Timecode source is cross-jammed (at a different **Project Time Base**).

---

## GENLOCK ICON

---



This icon indicates the state of the Genlock connection.



Gray indicates that no Genlock signal is detected.



Green indicates that the camera is receiving and is locked to a Genlock signal.



Red indicates that the camera is receiving and is not locked to a Genlock signal.

---

## SYNC ICON

---



This icon indicates that the Timecode and Genlock signals are synchronized to the camera's frames per second (FPS) settings.



Gray indicates that no synchronization is detected.



Green indicates that the camera is synchronized with the Timecode and Genlock signals.



Yellow indicates that the camera is synchronized with the a single camera or a Genlock signal.

---

## CAMERA STATUS ICON

---



This icon indicates the state of the camera hardware. The different icons and their corresponding status include:



Good



Overheating Warning



Overheating



Shutting Down

---

## FTPS ACTIVITY ICON

---



This icon indicates the state of FTPS data transfer.



Gray indicates that the FTPS is not transferring data.



Green indicates that the camera is transferring FTPS data.

---

## WI-FI ICON

---



This icon indicates the state of Wi-Fi connection.



Gray and empty indicates that no Wi-Fi signal is detected.



White bars indicate that Wi-Fi signal is detected (Infrastructure).



White antenna indicates that Wi-Fi signal is broadcasting (Ad-hoc).

---

## NETWORK ICON

---



This icon indicates the state of the network connection.



Gray indicates that the camera is not connected to a network.



Green indicates that the camera is connected to a network.

---

## LCD LOCK ICON

---



This icon indicates the state of the LCD Lock. The states include:



Gray and open indicates that the camera LCD is unlocked.



White and closed indicates that the camera LCD is locked.



## BATTERY ICON

---



This icon indicates the state of the battery connection and charge level.



Gray indicates that no battery is connected.



White indicates that the battery is connected and green shows the relative level of charge remaining.



Yellow indicates 10 minutes of power remaining.



Red indicates less than 5 minutes of power remaining.



Gray question mark indicates no communication with the battery and no power.



White question mark indicates no communication with the battery and power.



Gray exclamation point indicates error communicating with the battery and no power.

## DC-IN ICON

---



This icon indicates the state of DC power connection.



Gray indicates that no DC power is connected.



Green indicates that the camera is receiving DC power.

## 4. MENUS

This section describes the menus and sub-menus for the camera. To access the menus, navigate to a menu item from the LCD.

MENUS	DETAILS
Image / LUT Menu	ISO, Shutter, White Balance, Output Color Space, Output Tone Map, Highlight Roll-Off, 3D LUT, CDL, Exposure Adjust
Project Settings Menu	Format, Recording Frame Rate, Project Time Base, R3D Quality, Pre-Record, Slate
Audio / TC Menu	Audio Source, Internal Audio, External Audio, Headphone, Timecode Source, Jam Timecode to TOD, Timecode Display Mode
Monitoring Menu	Top LCD, SDI 1/2, Live Stream, Tools, Guides
Media Menu	Eject, Media Info, Secure Format
User Settings Menu	Presets, Side LCD, User 1, User 2, User 3
Autofocus - BETA Menu	Enable, Mode, Size, Position, Start AF
Communication Menu	Camera, USB-C, Wi-Fi, FTPS, Serial
System Settings Menu	Date / Time, Lens, Power, Indicators, Status Settings, System Status
Language Menu	English, Chinese, French, German, Japanese, Spanish
Maintenance Menu	Calibrate, Calibration, Save Log, Reset Defaults, Factory Reset, Upgrade

## IMAGE / LUT MENU

The Image / LUT menu contains the settings you use to configure your image.

From the camera LCD menu, navigate to Image / LUT and press SEL:

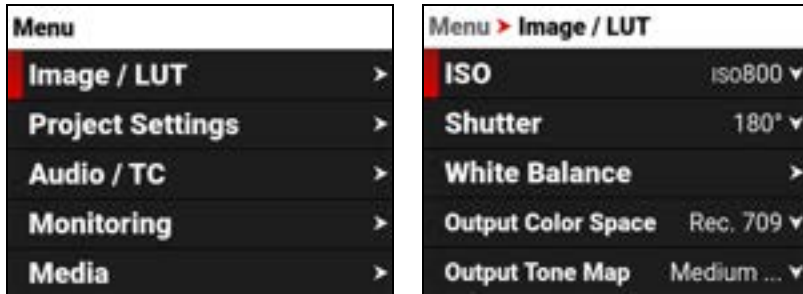

Use the Image / LUT menu to configure the camera's image and lookup table (LUT) settings:

ITEM	DETAILS
ISO	Adjusts the image's brightness in the monitoring path
Shutter	Adjusts the amount of light exposed to the sensor
White Balance	Adjusts the colors to compensate for the light source temperature
Output Color Space	Adjusts on-set working color space
Output Tone Map	Adjusts the image contrast
Highlight Roll-Off	Adjusts image highlight compression
3D LUT	Manage the camera's look up tables (LUTs)
CDL	Opens the Color Decision List (CDL) menu
Exposure Adjust	Manually fine-tunes the midtone exposure level

## ISO

Use the ISO setting to adjust the image's brightness in the monitoring path.

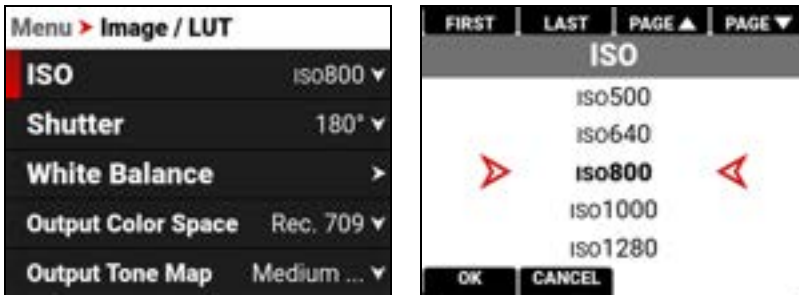

The ISO range is ISO 250 to ISO 12,800. The default ISO is ISO 800.

Higher ISO values create brighter images in the monitor path, and lower ISO values create darker images in the monitor path.

When you record, the ISO settings are stored as metadata and you can adjust them non-destructively in post-processing with REDCINE-X PRO or other editing tools that support R3D files.

RED recommends setting the ISO to the default of 800, then adjusting the aperture and lighting to match. You can adjust the ISO later for fine-tuning.

## SHUTTER

Use Shutter to select the exposure time (shutter speed / shutter angle). You can change the shutter settings while recording.



You can switch between angle and time by using the [Status Settings](#) or by pressing and holding the button above SHUTTER on the Home Page (refer to [Home Page](#)).

Decreasing shutter speed increases the amount of time that light hits the sensor, which increases exposure and motion blur of moving objects. Increasing shutter speed decreases the amount of time that light hits the sensor, which decreases exposure and motion blur of moving objects.

## SHUTTER ANGLE

Enter the exposure value as a shutter angle (xx°). The shutter angle range is 0° to 360°. The default shutter angle is 180°. Click Edit to enter an exact shutter angle or shutter speed.



## EXPOSURE CONVERSIONS

The table below lists common shutter angle and shutter speed equivalents. The calculations in the table use a recording frame rate of 23.98 fps.

SHUTTER ANGLE (°)	SHUTTER SPEED (1/XX SEC)	SHUTTER ANGLE (°)	SHUTTER SPEED (1/XX SEC)
360°	1/23.98	105°	1/82.20
288°	1/29.97	90°	1/95.90
270°	1/31.97	72°	1/119.88
240°	1/35.96	45°	1/191.81
225°	1/38.36	22.5°	1/383.62
180°	1/47.95	11.2°	1/770.66
172.8°	1/49.95	8.6°	1/1003.65
144°	1/59.94	4°	1/2157.84
135°	1/63.95	1°	1/8000 (max)
120°	1/71.93		

## SHUTTER SPEED

Enter the exposure value as a shutter speed (1/xx sec).

The slowest shutter speed is 1/(recording frame rate). For example, if the recording frame rate is 23.98 fps, the slowest available shutter speed is 1/23.98 sec. The fastest shutter speed is 1/8000 sec. The default shutter speed is 1/47.95 sec.

### CONVERT SHUTTER SPEED TO SHUTTER ANGLE

Shutter Angle = (Shutter Speed x Frame Rate x 360)

Example:  $(1/47.95 \times 23.98 \times 360) = 180$

### CONVERT SHUTTER ANGLE TO SHUTTER SPEED

Shutter Speed =  $1/(\text{Frame Rate} \times 360/\text{Angle})$

Example:  $1/(23.98 \times 360/180) = 1/47.95$

## WHITE BALANCE

Use the White Balance menu to adjust the **Color Temperature** and the **Tint**.

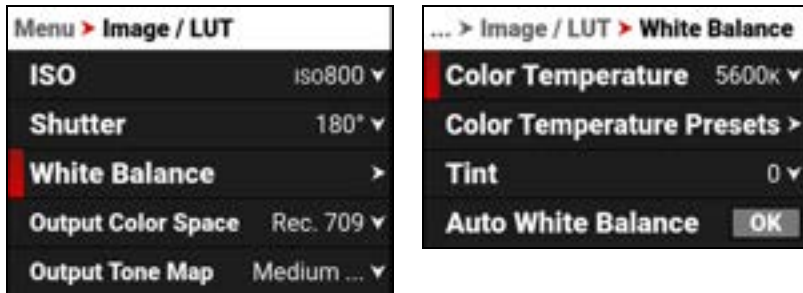

When shooting in R3D format, the camera stores white balance as metadata, which you can adjust non-destructively in post production after filming.

Use the White Balance menu to configure the color temperature and tint settings for your image:

ITEM	DETAILS
<b>Color Temperature</b>	Image color temperature correction
<b>Color Temperature Presets</b>	Select a preset color temperature
<b>Tint</b>	Adjust magenta-green color component
<b>Auto White Balance</b>	The camera automatically sets the color temperature and tint

## COLOR TEMPERATURE

Use Color Temperature to adjust the image's color temperature in Kelvin units (K) or by selecting presets.

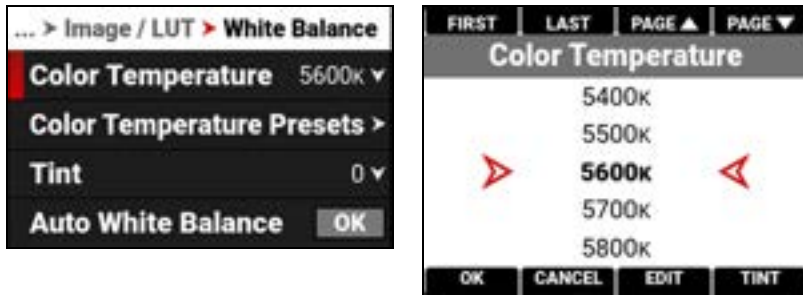

When the image's light source color temperature is warm, you can compensate by setting the camera to a warmer color temperature. When the image's light source color temperature is cool, you can compensate by setting the camera to a cooler temperature.

The color temperature range is 1,700 K to 10,000 K. The default color temperature is 5600 K.

When the White Balance List Mode (refer to [Status Settings](#)) is set to Presets, the Color Temperature menu list uses the Preset temperatures instead of the Kelvin temperatures.



## COLOR TEMPERATURE PRESETS

Use Color Temperature Presets to select a pre-configured color temperature.

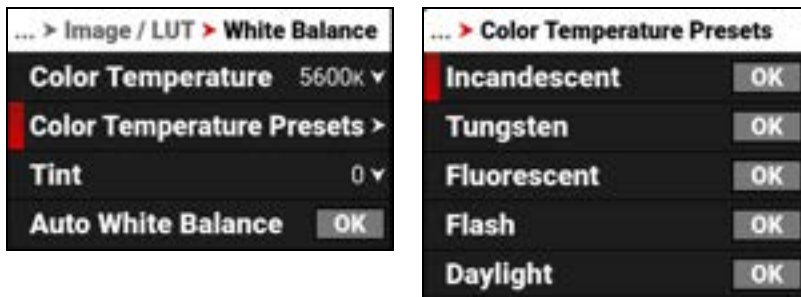

The color temperature presets you can select include:

ITEM	DETAILS	ITEM	DETAILS
Incandescent	2800 K	Daylight	5600 K
Tungsten	3200 K	Cloudy	7000 K
Fluorescent	4500 K	Shade	8000 K
Flash	5500 K		

## TINT

Use Tint to adjust the image's color tint.

Color temperature calculations assume a pure light source that may not be true in the specific scene the camera is imaging. To compensate for any residual colorcast, the Tint setting adjusts the RGB color balance with a compensating magenta-green color component.

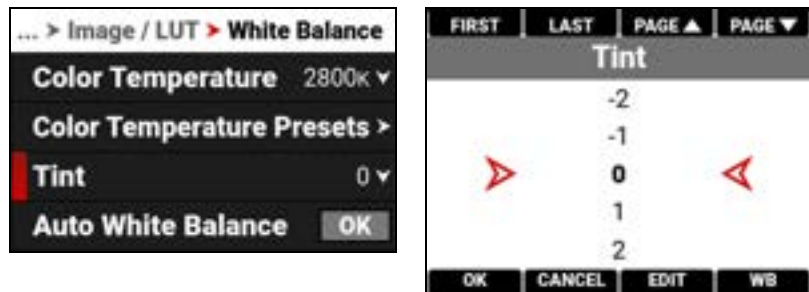

Tint range is -100 to 100. The default Tint setting is 0.

## AUTO WHITE BALANCE

Use Auto White Balance to use the camera's automatic white balance adjustment.



When shooting in R3D format, the camera stores white balance as metadata, which you can adjust non-destructively in post production after filming.

To use Auto White Balance:

1. Place an 18% gray chart in the center of the image under the correct exposure.
2. From the **White Balance** menu, navigate down to **Auto White Balance** and press SEL to enable.
3. The camera automatically sets the color temperature and tint settings.

**NOTE:** Place the chart in the same location as your subject, and illuminate it with the same lighting.



## OUTPUT COLOR SPACE

Use Output Color Space to select the desired Color Space to use when displaying the camera output.

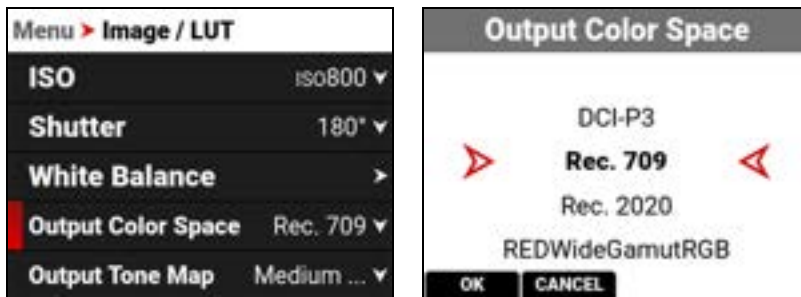

The Output Color Space selections include:

- DCI-P3 - Digital Cinema Initiatives theater projector standard color space
- Rec. 709 - Standard Color Space for HDTV (default)
- Rec. 2020 - Standard Color Space for UHD and HDR
- REDWideGamutRGB - Color space encompassing all of the colors that the RED camera can generate without clipping

## OUTPUT TONE MAP

Use Output Tone Map to adjust the image contrast when displaying the camera output.

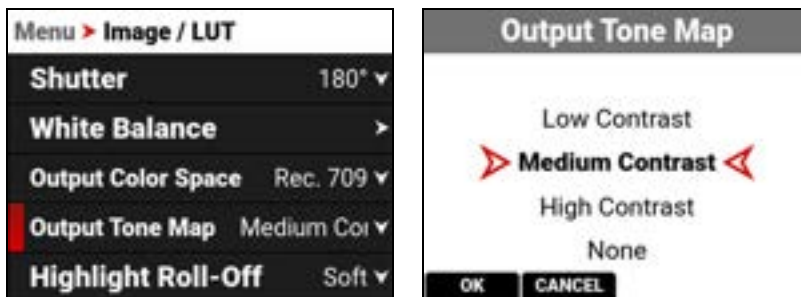

When shooting in R3D format, the camera stores this as metadata, which you can adjust non-destructively in post production after filming.

The Output Tone Map selections include:

- Low Contrast - Low contrast is applied to the image
- Medium Contrast - Medium contrast is applied to the image (default)
- High Contrast - High contrast is applied to the image
- None - No contrast is applied to the image

## HIGHLIGHT ROLL-OFF

Use Highlight Roll-Off to select the desired highlight compression to use when displaying the camera output.

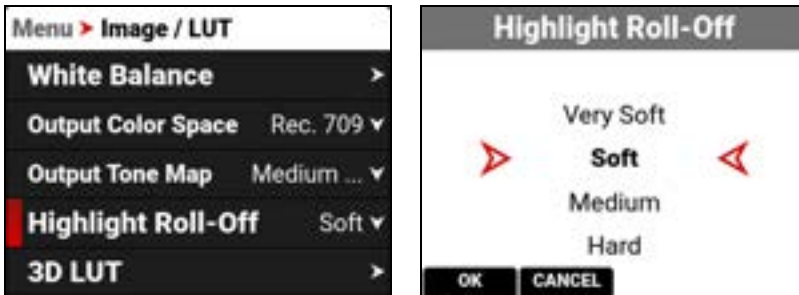

When shooting in R3D format, the camera stores this as metadata, which you can adjust non-destructively in post production after filming.

The Highlight Roll-Off selections include:

- Very Soft - The lightest compression is applied to the image highlights
- Soft - Soft compression is applied to the image highlights (default)
- Medium - Medium compression is applied to the image highlights
- Hard - The highest compression is applied to the image highlights
- None - Nothing is applied to the image highlights

## 3D LUT

Use the 3D LUT menu to apply and manage the camera's Look-Up Tables (LUTs).

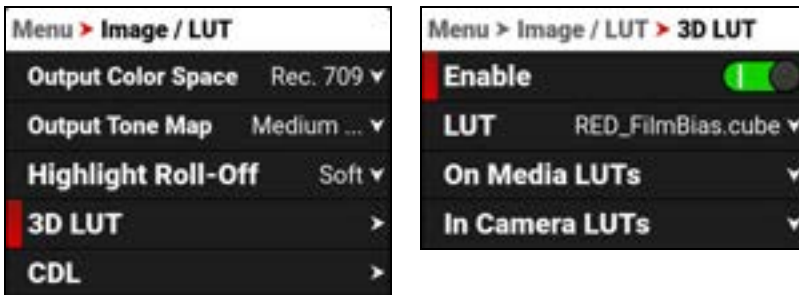

## LUT

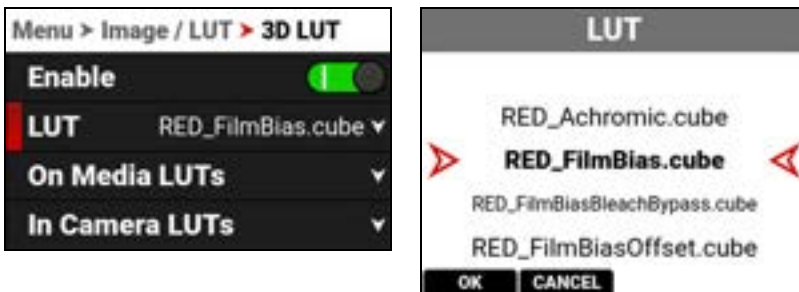

When you are recording, this LUT will be saved along with each clip on which it is activated during recording. The LUT is non-destructive, and it is reversible.

To apply a 3D LUT, follow the instructions below:

1. Go to **MENU > IMAGE / LUT > 3D LUT > LUT**.
2. Select a LUT from the LUT list.

## ON MEDIA LUTS

To import 3D LUTs from media, go to **MENU > IMAGE / LUT > 3D LUT > On Media LUTs**.

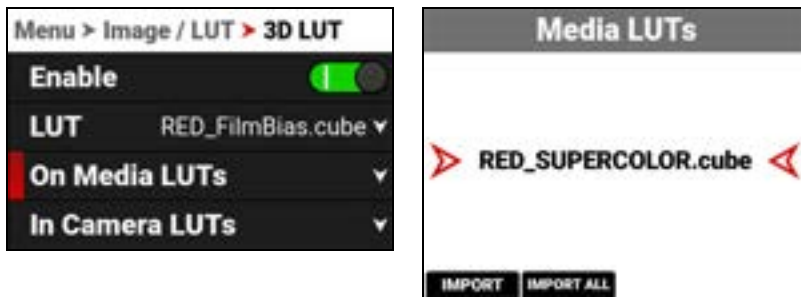

3D LUTs can be imported from media to the camera. When importing 3D LUTs from media to the camera, the 3D LUTs must be saved on the root path of your media, in a folder titled "luts."

From On Media LUTs you can:

- Import the selected 3D LUT from the media to the camera
- Import all 3D LUTs from the media to the camera

## IN CAMERA LUTS

To export and delete 3D LUTs stored in the camera, go to **MENU > IMAGE / LUT > 3D LUT > In Camera LUTs**.



You can export 3D LUTs stored on the camera, to media, to use on other cameras. When you export 3D LUTs from the camera to media, the 3D LUTs are saved to a folder on the media called "luts."

**NOTE:** When a LUT is active during record, it will automatically be saved along with the recorded clip.

From In Camera LUTs you can:

- Delete a selected 3D LUT from the camera
- Export a selected 3D LUT from the camera to the media
- Export all 3D LUTs from the camera to the media

## CDL

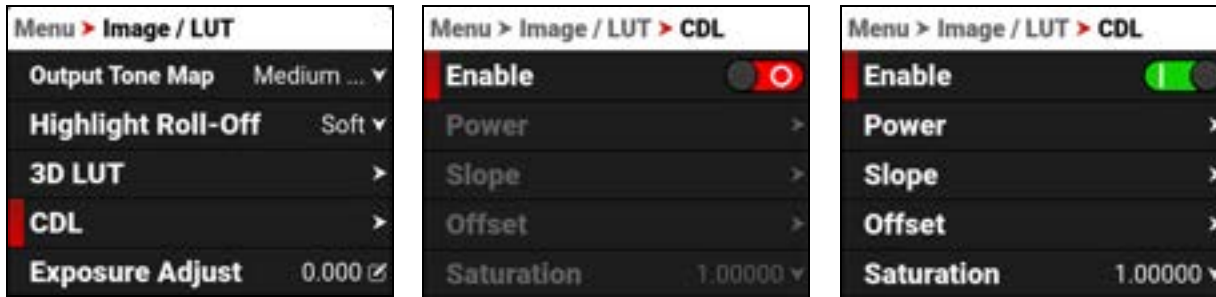

The Color Decision List (CDL) allows you define the look of the camera's colors in your project.

Use the CDL menu to:

- Enable the CDLs
- Configure **CDL Power**
- Configure **CDL Slope**
- Configure **CDL Offset**
- Configure **CDL Saturation**

## MANAGE CDLS

Use the CDLs menu to import and export CDLs.

CDLs can be stored on the camera or transferred to media to be shared with other cameras. When exporting CDLs from camera to media, the CDLs are saved to a folder on the media called “cdls”. When importing CDLs from media to the camera, the CDLs must be stored on the media in a folder called “cdls.”

**NOTE:** When you record with a CDL, the camera automatically saves the CDL together with the clip.

To export selected CDLs from the camera to the media, refer to the **In Camera CDLs** section.

To import selected CDLs from the media to the camera, refer to the **On Media CDL** section.

## CDL OVERVIEW

A Color Decision List (CDL) is a metadata file format developed by the American Society of Cinematographers (ASC) to exchange standard color correction information between post production tools. This non-destructive color adjustment layer simplifies the versioning of looks by updating simple metadata without the need to re-transfer the image data.

CDLs are very common in VFX workflows because the VFX artist needs both the ungraded shot and the intended look. The ungraded shot allows the artist to comp in truly linear light, and the intended look is needed to confirm that the individual plates still hold together after the grade is applied.

## SLOPE, OFFSET AND POWER

The three CDL tone curve parameters are Slope, Offset and Power. These algorithms allow the camera to modify the recorded image.

- Slope multiplies the incoming data
- Offset is sum of the incoming data
- Power is a power function to the incoming data

These three relate to Gain, Lift, and Gamma in the following ways:

- Slope = Gain  
Gain Adjusts highlights.
- Offset = Lift  
Lift Increases the value of dark colors.
- Power = Gamma  
Gamma adjusts midtones.

These three relate to each other in the following ways:

Slope= input x slope

Offset= (input x slope) + offset

Power= ((input x slope) + offset) ^ power

The formula for ASC CDL color correction is:

$$out = ((i \times s) + o)^p$$

where

- out** is the color graded pixel code value
- i** is the input pixel code value (0=black, 1=white)
- s** is slope (any number 0 or greater, nominal value is 1.0)
- o** is offset (any number, nominal value is 0)
- p** is power (any number greater than 0, nominal value is 1.0)

The formula is applied to the three color values for each pixel using the corresponding slope, offset, and power numbers for each color channel.

## SATURATION

A fourth parameter “Saturation” is achieved by converting the *out* data in a Luma and Chroma component. The Chroma Signal is then multiplied by the “Saturation” parameter.

## FILM GRADE AND VIDEO GRADE

With Slope and Offset you can produce both a Film Grade “Exposure” and “Contrast” and a Video Grade “Lift” and “Gain”.

- Exposure is achieved by Offset
- Contrast is achieved by a combination of Offset and Slope
- Gain is achieved by Slope
- Lift is achieved by a combination of Offset and Slope
- Gamma is achieved by Power

## CDL POWER

The CDL Power settings control the power of the Red, Green, Blue, color data.

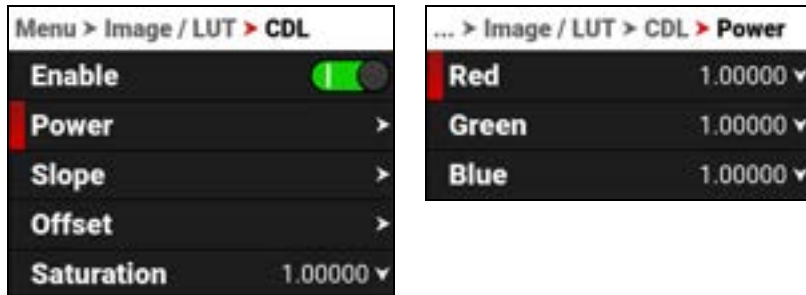

Use the CDL Power menu to adjust the power of the Red, Green, and Blue CDL data.

## CDL POWER SETTINGS

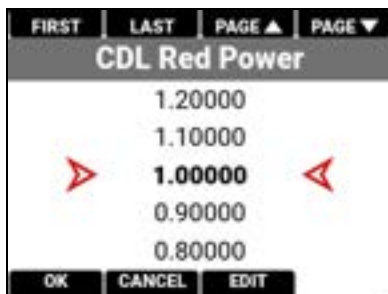

The CDL Power settings range from 0.00000 to 4.00000. The default CDL Power setting for each color is 1.00000.

## CDL SLOPE

The CDL Slope settings multiply the incoming RGB data.



Use the CDL Slope menu to set the slope of the red, green, and blue signals.

## SLOPE SETTINGS



The CDL Slope settings range from 0.00000 to 2.00000. The default CDL Slope setting for each color is 1.00000.

## CDL OFFSET

The CDL Offset settings control the offset of the RGB color data.

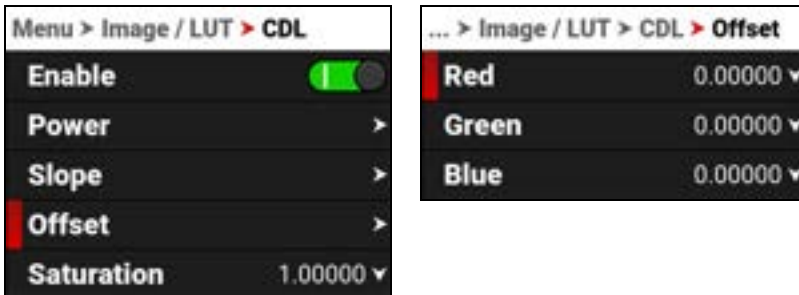

Use the CDL Offset menu to adjust the offset of the **CDL Slope** for the Red, Green, and Blue CDL data.

## RED GREEN AND BLUE OFFSETS

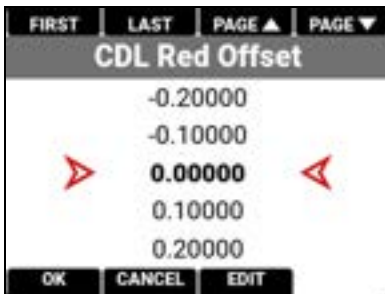

These CDL Offset settings range from -1.00000 to 1.00000. The default CDL Offset setting for each color is 0.00000.

## CDL SATURATION



The CDL Saturation settings control the intensity of the color data.

Use the CDL Saturation menu to adjust the intensity of the image color.

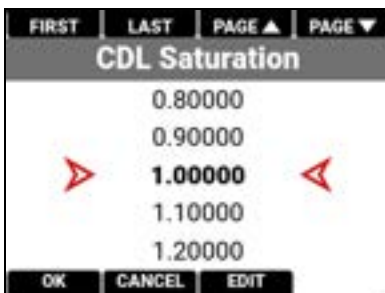

The CDL Saturation settings range from 0.00000 to 4.00000. The default CDL Saturation setting is 1.00000.



## ON MEDIA CDL

Use On Media CDLs to copy CDLs stored on the media and store them on the camera.

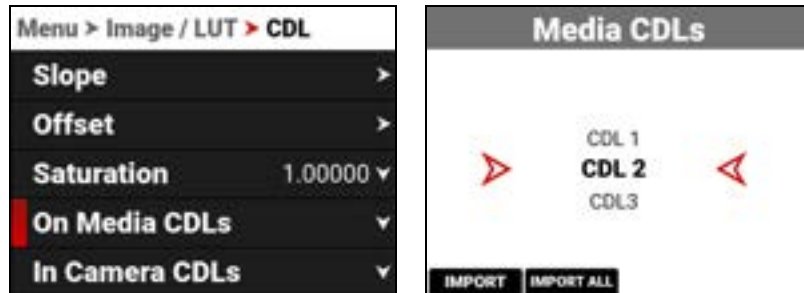

CDLs can be imported from media to the camera. When importing CDLs from media to the camera, the CDLs are saved to a folder on the camera called "cdls."

From Media CDLs you can import the selected CDL from the media to the camera or import all of the CDLs from the media to the camera.

## IN CAMERA CDLS

Use In Camera CDLs to copy CDLs stored on the camera and store them on the media. You can also select which stored CDLs you want the camera to use.

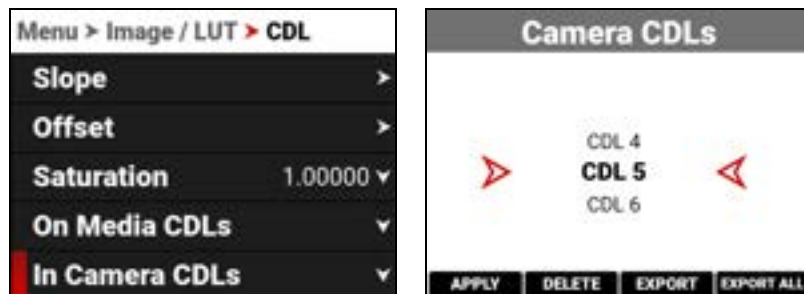

CDLs can be exported from the camera to the media. When exporting CDLs from camera to the media, the CDLs are saved to a folder on the media called "cdls."

From Camera CDLs you can apply the selected CDL to the camera, delete the selected CDL from the camera, export the selected CDL from the camera to the media, or export all of the CDLs from the camera to the media.

## EXPOSURE ADJUST

Use Exposure Adjust to manually fine-tune the midtone exposure level.

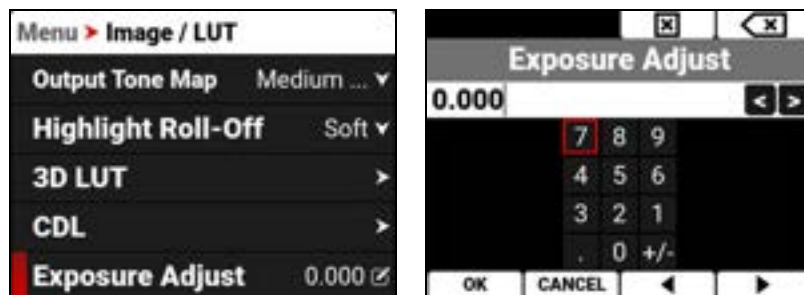

The Exposure Adjust range is -8.000 to 8.000. The default is 0.000.

Exposure Adjust allows you to adjust the midtone exposure levels while preserving the highlights and shadows, even when changed substantially. The Exposure Adjust setting is expressed in terms of relative exposure value (EV), where each unit represents a 1-stop change in midtone exposure level.



## PROJECT SETTINGS MENU

The Project Settings menu contains the camera's main recording configuration settings.

From the camera LCD menu, navigate to Project Settings and press SEL:



Use the Project Settings menu to configure the recording settings:

ITEM	DETAILS
Format	Size of the area captured by the sensor
Recording Frame Rate	Frames recorded per second
Project Time Base	Image playback rate
R3D Quality	Compression level of the recorded image file
Pre-Record	Enable and configure a pre-record clip
Slate	Camera ID and camera position

## FORMAT

Use the Format setting to designate how much of the sensor the camera should use to capture images.

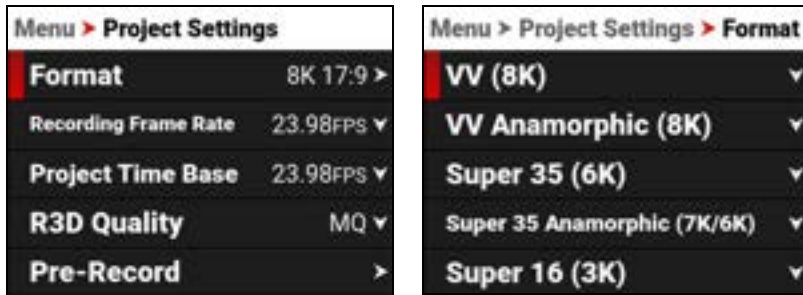

Use the Format menu to configure the camera's sensor capture area settings:

ITEM	DETAILS
VV (8K)	Select from VV (8K) sensor capture areas
VV Anamorphic (8K)	Select from VV anamorphic (8K) sensor capture areas
Super 35 (6K)	Select from Super 35 (6K) sensor capture areas
Super 35 Anamorphic (7K/6K)	Select from Super 35 anamorphic (7K/6K) sensor capture areas
Super 16 (3K)	Select from Super 16 (3K) sensor capture areas
All Formats	Select from all sensor capture areas

The available aspect ratios are determined by the selected resolution. The default format setting is 8K 17:9.

When you lower the resolution on the camera, only a portion of the sensor is used. The camera does not downscale from the 8K 17:9 format when recording RAW.

## VV (8K)

Use the VV (8K) format setting to designate how much of the sensor the camera should use to capture images.

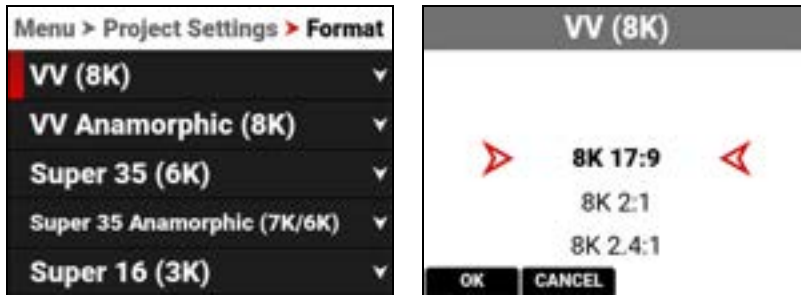

The available aspect ratios are determined by the selected resolution.

## VV (8K) FORMAT SPECIFICATIONS

This table contains the dimensions of the sensor area in Pixels and in Millimeters used by each VV (8K) format. These dimensions are close approximations.

The default format is 8K 17:9.

FORMAT	DIMENSION (PIXELS)		DIMENSIONS (MM)		
	Width	Height	Width	Height	Diagonal
8K 17:9	8192	4320	40.96	21.6	46.31
8K 2:1	8192	4096	40.96	20.48	45.79
8K 2.4:1	8192	3456	40.96	17.28	44.46
8K 16:9	7680	4320	38.40	21.6	44.06
8K 1:1	4320	4320	21.6	21.6	30.55

## VV ANAMORPHIC (8K)

Use the VV Anamorphic (8K) format setting to designate how much of the sensor the camera should use to capture anamorphic images with the appropriate de-squeeze ratio.

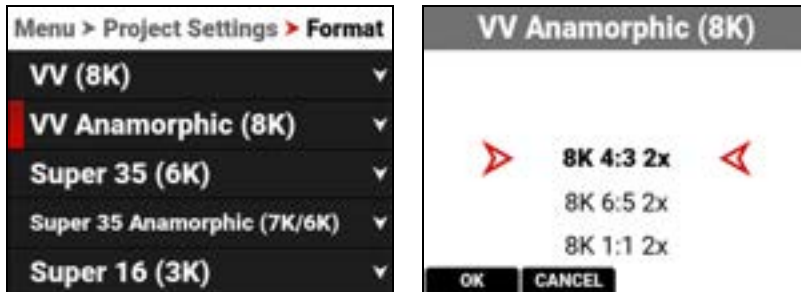

The available aspect ratios are determined by the selected resolution.

When you lower the resolution on the camera, only a portion of the sensor is used. The camera does not downscale from the format when recording RAW.

## VV ANAMORPHIC (8K) FORMAT SPECIFICATIONS

This table contains the dimensions of the sensor area in Pixels and in Millimeters used by each VV Anamorphic (8K) format. These dimensions are close approximations.

The default format is 8K 4:3 2x.

FORMAT	DIMENSION (PIXELS)		DIMENSIONS (MM)		
	Width	Height	Width	Height	Diagonal
8K 4:3 2x	5760	4320	28.80	21.60	36.00
8K 6:5 2x	5184	4320	25.92	21.60	33.74
8K 1:1 2x	4320	4320	21.60	21.60	30.55
8K 3:2 1.8x	6480	4320	32.40	21.60	38.94
8K 4:3 1.8x	5758	4320	28.80	21.60	36.00
8K 3:2 1.6x	6480	4320	32.40	21.60	38.94
8K 16:9 1.5x	7680	4320	38.40	21.60	44.06
8K 17:9 1.3x	8192	4320	40.96	21.60	46.31
8K 16:9 1.3x	7680	4320	38.40	21.60	44.06
8K 17:9 1.25x	8192	4320	40.96	21.60	46.31

## SUPER 35 (6K)

Use the Super 35 (6K) format setting to designate how much of the sensor the camera should use to capture images.

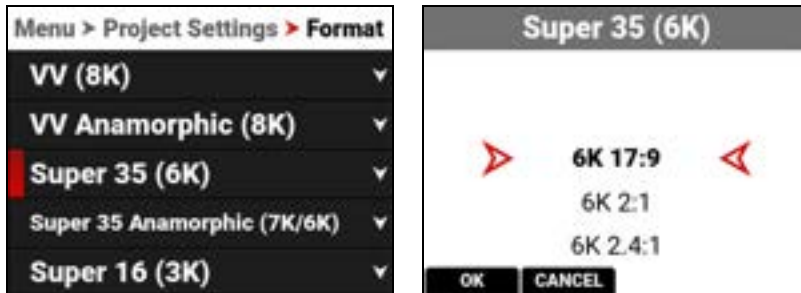

The available aspect ratios are determined by the selected resolution.

When you lower the resolution on the camera, only a portion of the sensor is used. The camera does not downscale from the 6K 17:9 format when recording RAW.

## SUPER 35 (6K) FORMAT SPECIFICATIONS

This table contains the dimensions of the sensor area in Pixels and in Millimeters used by each Super 35 (6K) format. These dimensions are close approximations.

The default format is 6K 17:9.

FORMAT	DIMENSION (PIXELS)		DIMENSIONS (MM)		
	Width	Height	Width	Height	Diagonal
6K 17:9	6144	3240	30.72	16.20	34.73
6K 2:1	6144	3072	30.72	15.36	34.35
6K 2.4:1	6144	2592	30.72	12.87	33.31
6K 16:9	5760	3240	28.80	16.20	33.04
6K 1:1	3240	3240	16.20	16.20	22.91

## SUPER 35 ANAMORPHIC (7K/6K)

Use the Super 35 Anamorphic Format setting to designate how much of the sensor the camera should use to capture images.



The available aspect ratios are determined by the selected resolution.

When you lower the resolution on the camera, only a portion of the sensor is used. The camera does not downscale from the format when recording RAW.

## SUPER 35 ANAMORPHIC (7K/6K) FORMAT SPECIFICATIONS

This table contains the dimensions of the sensor area in Pixels and in Millimeters used by each Super 35 Anamorphic (7K/6K) format. These dimensions are close approximations.

The default setting is 7K 4:3 2x.

FORMAT	FILM EQUIVALENT	DIMENSION (PIXELS)		DIMENSIONS (MM)		
		Width	Height	Width	Height	Diagonal
7K 4:3 2x	Super 35 mm 4-Perf	5040	3780	25.20	18.90	31.50
7K 6:5 2x	Super 35 mm 4-Perf	4536	3780	22.68	18.90	29.52
7K 1:1 2x	Super 35 mm 4-Perf	3780	3780	18.90	18.90	26.73
7K 3:2 1.8x	Super 35 mm 4-Perf	5670	3780	28.35	18.90	28.14
7K 4:3 1.8x	Super 35 mm 4-Perf	5040	3780	25.20	18.90	31.50
7K 3:2 1.6x	Super 35 mm 4-Perf	5670	3780	28.35	18.90	28.14
6K 16:9 1.5x	Super 35 mm 3-Perf	5760	3240	28.80	16.20	33.04
6K 17:9 1.3x	Super 35 mm 3-Perf	6144	3240	30.72	16.20	34.73
6K 16:9 1.3x	Super 35 mm 3-Perf	5760	3240	28.80	16.20	33.04
6K 17:9 1.25x	Super 35 mm 3-Perf	6144	3240	30.72	16.20	34.73

## SUPER 16 (3K)

Use the Super 16 (3K) format setting to designate how much of the sensor the camera should use to capture images.

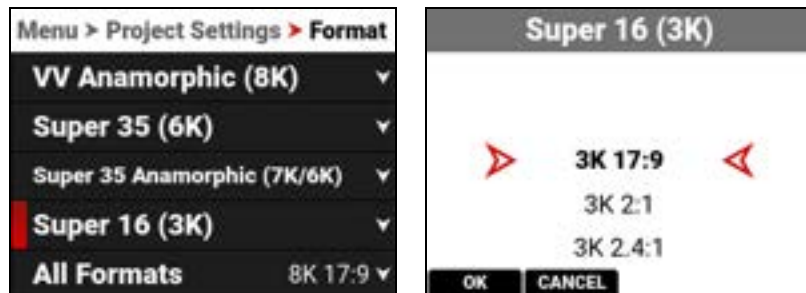

The available aspect ratios are determined by the selected resolution.

When you lower the resolution on the camera, only a portion of the sensor is used. The camera does not downscale from the format when recording RAW.

## SUPER 16 (3K) FORMAT SPECIFICATIONS

This table contains the dimensions of the sensor area in Pixels and in Millimeters used by each Super 16 (3K) format. These dimensions are close approximations.

The default format is 3K 17:9.

FORMAT	DIMENSION (PIXELS)		DIMENSIONS (MM)		
	Width	Height	Width	Height	Diagonal
3K 17:9	3072	1620	15.36	8.10	17.36
3K 2:1	3072	1536	15.36	7.68	17.17
3K 2.4:1	3072	1296	15.36	6.48	16.67
3K 16:9	2880	1620	14.40	8.10	16.52
3K 1:1	1620	1620	8.10	8.10	11.46

## ALL FORMATS

Use the All Formats setting to select from all of the possible formats to designate how much of the sensor the camera should use to capture images.

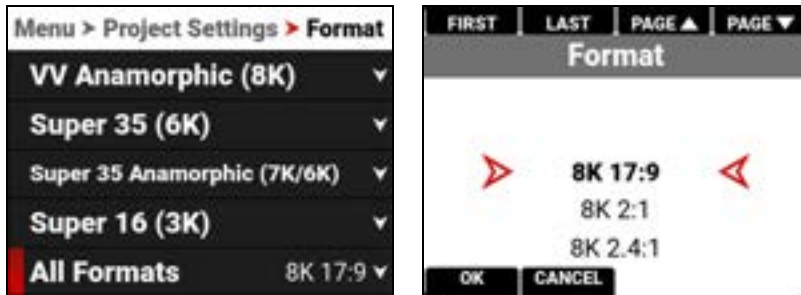

The available aspect ratios are determined by the selected resolution.

When you lower the resolution on the camera, only a portion of the sensor is used. The camera does not downscale from the 8K 17:9 format when recording RAW.

## FORMAT SPECIFICATIONS

This table contains the dimensions of the sensor area in Pixels and in Millimeters used by all of the camera formats. These dimensions are close approximations. The default setting is 8K 17:9.

FORMAT	DIMENSION (PIXELS)		DIMENSIONS (MM)		
	Width	Height	Width	Height	Diagonal
8K 17:9	8192	4320	40.96	21.6	46.31
8K 2:1	8192	4096	40.96	20.48	45.79
8K 2.4:1	8192	3456	40.96	17.28	44.46
8K 16:9	7680	4320	38.40	21.6	44.06
8K 1:1	4320	4320	21.6	21.6	30.55
8K 4:3 2x	5760	4320	28.80	21.60	36.00
8K 6:5 2x	5184	4320	25.92	21.60	33.74
8K 1:1 2x	4320	4320	21.60	21.60	30.55
8K 3:2 1.8x	6480	4320	32.40	21.60	38.94
8K 4:3 1.8x	5758	4320	28.80	21.60	36.00
8K 3:2 1.6x	6480	4320	32.40	21.60	38.94
8K 16:9 1.5x	7680	4320	38.40	21.60	44.06
8K 17:9 1.3x	8192	4320	40.96	21.60	46.31
8K 16:9 1.3x	7680	4320	38.40	21.60	44.06
8K 17:9 1.25x	8192	4320	40.96	21.60	46.31
7K 17:9	7168	3780	35.84	18.90	40.52
7K 2:1	7168	3584	35.84	17.92	40.07
7K 2.4:1	7168	3002	35.84	15.01	38.86
7K 16:9	6720	3780	33.60	18.90	38.55
7K 1:1	3780	3780	18.90	18.90	26.73
7K 4:3 2x	5040	3780	25.20	18.90	31.50



# V-RAPTOR™ 8K VV OPERATION GUIDE

FORMAT	DIMENSION (PIXELS)		DIMENSIONS (MM)		
	Width	Height	Width	Height	Diagonal
7K 6:5 2x	4536	3780	22.68	18.90	29.52
7K 1:1 2x	3780	3780	18.90	18.90	26.73
7K 3:2 1.8x	5670	3780	28.35	18.90	28.14
7K 4:3 1.8x	5040	3780	25.20	18.90	31.50
7K 3:2 1.6x	5670	3780	28.35	18.90	28.14
6K 17:9	6144	3240	30.72	16.20	34.73
6K 2:1	6144	3072	30.72	15.36	34.35
6K 2.4:1	6144	2592	30.72	12.87	33.31
6K 16:9	5760	3240	28.80	16.20	33.04
6K 1:1	3240	3240	16.20	16.20	22.91
6K 16:9 1.5x	5760	3240	28.80	16.20	33.04
6K 17:9 1.3x	6144	3240	30.72	16.20	34.73
6K 16:9 1.3x	5760	3240	28.80	16.20	33.04
6K 17:9 1.25x	6144	3240	30.72	16.20	34.73
5K 17:9	5120	2700	25.60	13.50	28.94
5K 2:1	5120	2560	25.60	12.80	28.62
5K 2.4:1	5120	2160	25.60	10.80	27.78
5K 16:9	4800	2700	24.00	13.50	27.54
5K 1:1	2700	2700	13.50	13.50	19.09
4K 17:9	4096	2160	20.48	10.80	23.15
4K 2:1	4096	2048	20.48	10.24	22.90
4K 2.4:1	4096	1728	20.48	8.64	22.23
4K 16:9	3840	2160	19.20	10.80	22.03
4K 1:1	2160	2160	10.80	10.80	15.27
3K 17:9	3072	1620	15.36	8.10	17.36
3K 2:1	3072	1536	15.36	7.68	17.17
3K 2.4:1	3072	1296	15.36	6.48	16.67
3K 16:9	2880	1620	14.40	8.10	16.52
3K 1:1	1620	1620	8.10	8.10	11.46
2K 17:9	2048	1080	10.24	5.40	11.58
2K 2:1	2048	1024	10.24	5.12	11.45
2K 2.4:1	2048	864	10.24	4.32	11.11
2K 16:9	1920	1080	9.60	5.40	11.01
2K 1:1	1080	1080	5.40	5.40	7.64

## RECORDING FRAME RATE

Use Recording Frame Rate to select the recording frame rate (also referred to as the capture frame rate).

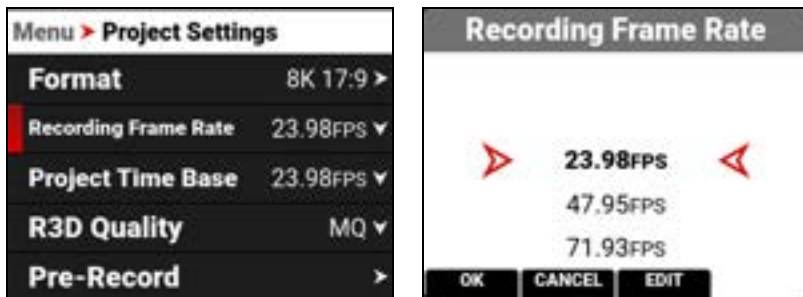

The recording frame rate is the number of frames per second (FPS) that are recorded. The recording frame rate is different from the project time base, which is the rate at which the footage will be played back.

The maximum frame rate for each format is determined by **Project Time Base** and **Format**.

When you select a Project Time Base, the camera automatically selects a matching Recording Frame Rate and an R3D Quality (when possible). You must change the Recording Frame Rate and R3D Quality after the Project Time Base to select a different setting.

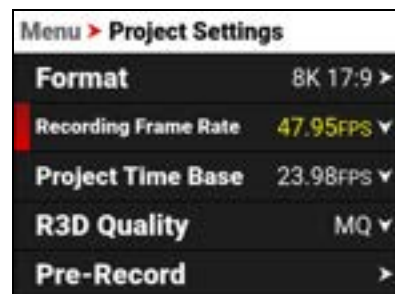

A Recording Frame Rate highlighted in **yellow** will result in playback occurring at a different frame rate than the original recording, and will record varispeed audio.

## FORMATS AND FRAME RATES

This table lists the camera's maximum recording frame rates. These rates are based on a Project Time Base setting of 24 frames per second (24 FPS).

FORMAT	MAX FPS
8K 17:9	120
8K 2:1	126
8K 2.4:1	150
8K 16:9	120
8K 1:1	120
7K 17:9	140
7K 2:1	144
7K 2.4:1	175
7K 16:9	137
7K 1:1	137
6K 17:9	160
6K 2:1	168

<b>FORMAT</b>	<b>MAX FPS</b>
6K 2.4:1	200
6K 16:9	160
6K 1:1	160
5K 17:9	192
5K 2:1	202
5K 2.4:1	240
5K 16:9	192
5K 1:1	192
4K 17:9	240
4K 2:1	253
4K 2.4:1	300
4K 16:9	240
4K 1:1	240
3K 17:9	320
3K 2:1	337
3K 2.4:1	400
3K 16:9	320
3K 1:1	320
2K 17:9	480
2K 2:1	505
2K 2.4:1	600
2K 16:9	480
2K 1:1	480

## PROJECT TIME BASE

Use the Project Time Base setting to choose the playback rate for the recorded footage.



The following project time bases are available:

- 23.98 FPS (Default)
- 24.00 FPS
- 25.00 FPS
- 29.97 FPS
- 30.00 FPS
- 50.00 FPS
- 59.94 FPS
- 60.00 FPS

When you select the Project Time Base, it changes the Recording Frame Rate to the same setting (when possible).

When you change the Format, the Recording Frame Rate and Project Time Base do not automatically update. You must select the Project Time Base after you change the Format setting.

## R3D QUALITY

Use R3D Quality to select the R3D data rate the camera uses to record the image files.

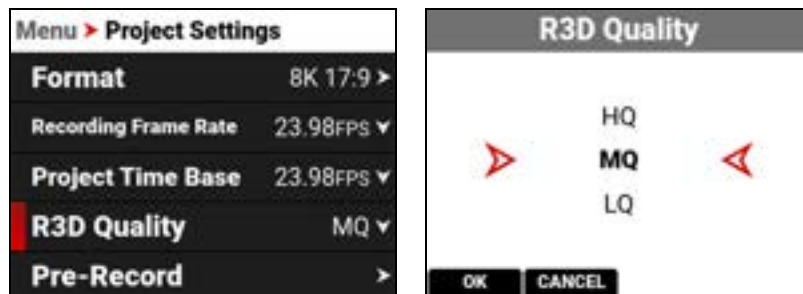

The R3D Quality selections include:

- HQ - High data rate and less recording time
- MQ - Medium data rate (default) and longer recording time
- LQ - Lowest data rate and longest recording time

For high complexity scenes, VFX, and stills from motion workflows, RED recommends the HQ setting. For cinema (non-VFX) and high-end TV, RED recommends the MQ setting. For TV, online content, documentary and interviews, RED recommends the LQ setting.

## PRE-RECORD

Use the Pre-Record menu to enable or disable Pre-Record, and to adjust the length of the Pre-Recorded clip.

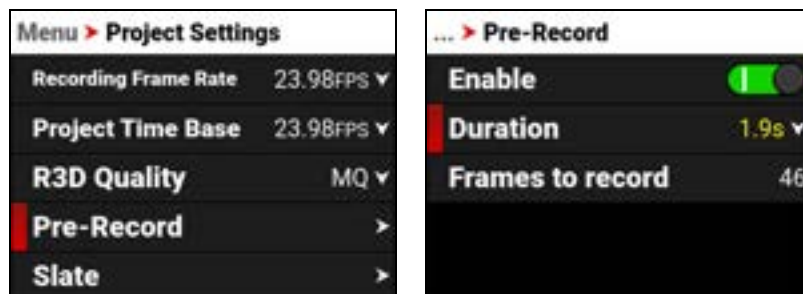

Pre-Record allows you to continually capture images to a small amount of memory while waiting to begin recording. This allows you to capture unexpected events such as, a whale breaching the water, or an athlete scoring a goal. When you finish recording, the pre-recorded clip is added to the beginning of the recording.

You can set the Pre-Record clip to record from half a second up to 30 seconds, depending on the format, file type, resolution, and quality. The default setting is 2 seconds at the default Project Time Base of 23.98 FPS.

For more information, refer to [Pre-Recording Content](#).

## SLATE

Use the Slate menu to assign a camera ID and camera position the camera adds when recording clips.

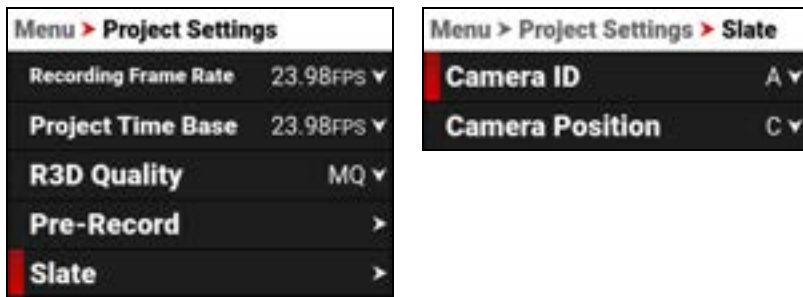

The settings you can assign to a clip include:

- Camera ID (also populates in the Media menu when formatting media)
- Camera Position (also populates in the Media menu when formatting media)

## CAMERA ID

Use Camera ID to assign a camera ID when the camera records clips.

**NOTE:** You can also change the Camera ID by using Secure Format (refer to [Secure Format](#)).

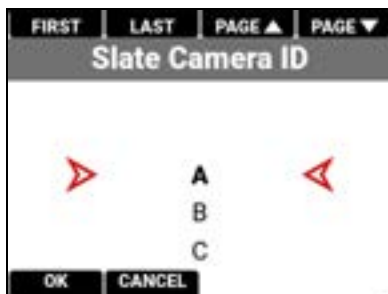

The camera IDs you can assign when recording a clip include the letters A-Z.

## CAMERA POSITION

Use Camera Position to assign a camera position letter when the camera records clips.

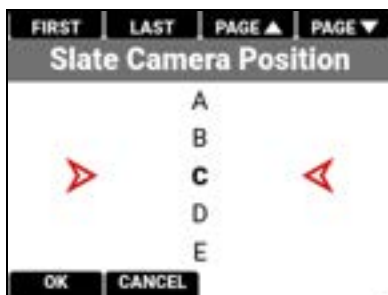

The camera positions you can assign when recording a clip include the letters A-Z.

## AUDIO / TC MENU

The Audio / TC menu contains the settings you use to configure your camera audio and Timecode.

From the camera LCD menu, navigate to Audio / TC and press SEL:

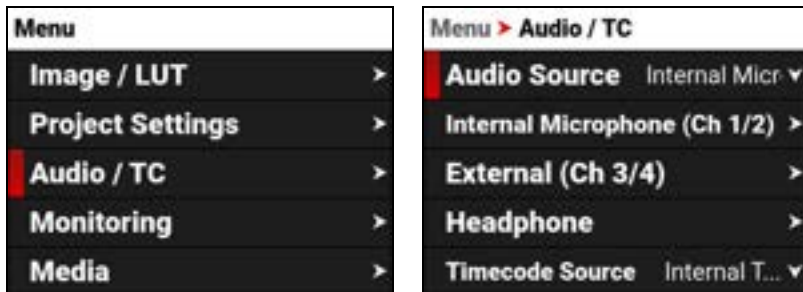

Use the Audio / TC menu to configure the audio and Timecode settings for the camera:

ITEM	DETAILS
Audio Source	Audio input source
Internal Microphone (Ch 1/2)	Left and Right internal microphone levels
External (Ch 3/4)	Left and Right external audio levels
Headphone	Headphone volume level
Timecode Source	Timecode source
Jam Timecode to TOD	Button to Jam Timecode to Time of Day (TOD)
Timecode Display Mode	Timecode to display

## AUDIO DETAILS

The camera is equipped with two integrated microphones suitable for scratch-track audio (Ch 1 and 2), and it is equipped with a 5-pin XLR audio connector that accepts 2-channel audio, Line, Mic, and +48V Phantom Power for external audio (Ch 3 and 4).

You can link the gain for the two internal and external channels together. This allows you to adjust the two internal (or external) channels together as one.

You can record audio from the internal microphones, from the external audio connector (2-channel recording), or from internal and external sources combined as 24-bit 48 kHz uncompressed audio tracks.

You can adjust the external audio by using the appropriate camera gain-settings (-52.5 dB to 36.0 dB). The default camera gain setting is 0 dB.

The camera's audio data is synchronized with video and timecode, and it is embedded in the R3D file. You can export the audio data as separate audio files by using REDCINE-X PRO, if needed. The camera also embeds the audio in the SDI output.

You can monitor the audio during recording and playback by using the equipped 3.5 mm stereo headphone port.

## VARISPEED AUDIO

This camera has the ability to record audio when the camera's Recording Frame Rate is set to a higher speed than the Project Time Base setting (Varispeed mode).

**NOTE:** The camera records the audio as a separate WAV file and stores it in the clip's RDC folder on the media drive.

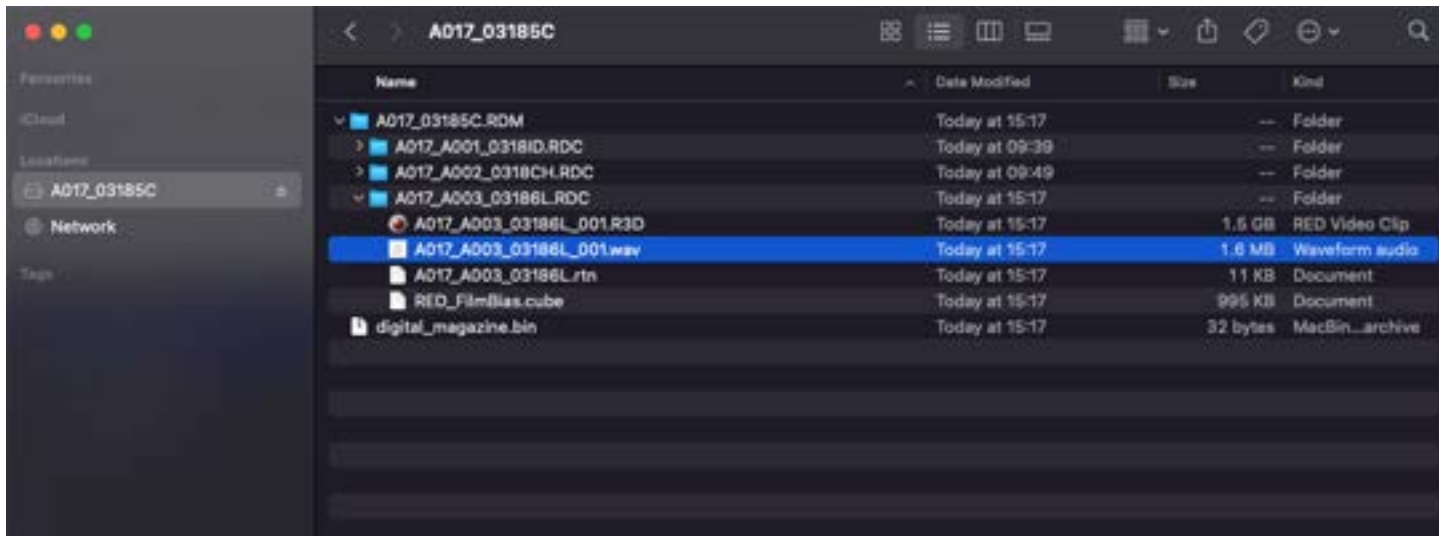

## TIMECODE DETAILS

Timecode provides a mechanism to reference frames from the camera's recorded clips to external devices such as, other cameras or audio recorders. Some devices can also gather additional data such as, lens metadata, or camera orientation, which Timecode can later use for merging the data back together in post-processing.

The camera provides two separate Timecode formats:

- **Time Of Day (TOD)** - The camera records the time of day as the Timecode for each clip
- **Edgecode** - The camera records elapsed time as the Timecode for each clip. The time is reset to 01:00:00 when a new media card is inserted in the camera. All of the clips on the media will have a continuous Timecode track. However, each new media card will default to a Timecode track starting at 01:00:00. You can change the Edgecode to begin at any desired time by using the Media Format menu (refer to [Edgecode](#)).

The camera synchronizes (jams) the TOD Timecode to an external Timecode generator (when one is connected to the camera) or it jams the Timecode to its internal real-time clock.

The camera stores TOD and Edge Timecode in the R3D file. You can select which one you want to display on the [LCD](#).

## AUDIO SOURCE

Use the Audio Source settings to select the audio input source.

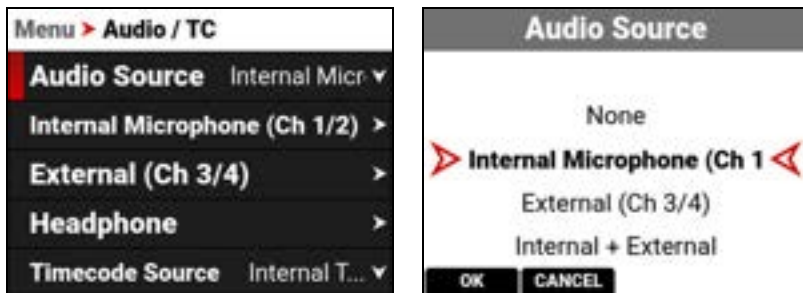

The audio input sources include:

- None
- Internal Microphone (Ch 1/2) - enables the **Internal Microphone (Ch 1/2)** menu (default)
- External (Ch 3/4) - enables the **External (Ch 3/4)** menu
- Internal + External - enables all audio sources

**NOTE:** The headphones can only monitor the internal microphone channels (Ch 1 and 2) or the external audio channels (Ch 3 and 4).

## INTERNAL MICROPHONE (CH 1/2)

Use the Internal Microphone (Ch 1/2) settings to set the left and right internal audio levels (channels 1 and 2). This menu is only enabled when the Audio Source is set to Internal Microphone or Internal + External.

**NOTE:** When the Recording Frame Rate and Project Time Code settings are different, varispeed audio is recorded (refer to **Audio / TC Menu**).

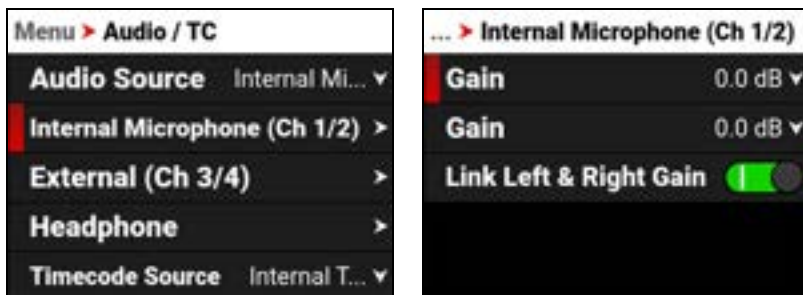



The Internal Microphone is represented as Channels 1 and 2 on the Home Page and on the Audio Channels 1/2 Page VU Meters (refer to **LCD** for more information). The left channel is channel 1 and the right channel is channel 2.



You can adjust the internal audio levels for left and right from -52.5 dB to 36.0 dB.

The default setting is 0 dB.

When you enable Link Left & Right Gain, the channels are linked together and adjusted as one.

## EXTERNAL (CH 3/4)

Use the External audio settings to set the left and right external audio levels. This menu is only enabled when the **Audio Source** is set to External (Ch 3/4) or Internal + External.

**NOTE:** When the Recording Frame Rate and Project Time Code settings are different, varisped audio is recorded (refer to **Audio / TC Menu**).

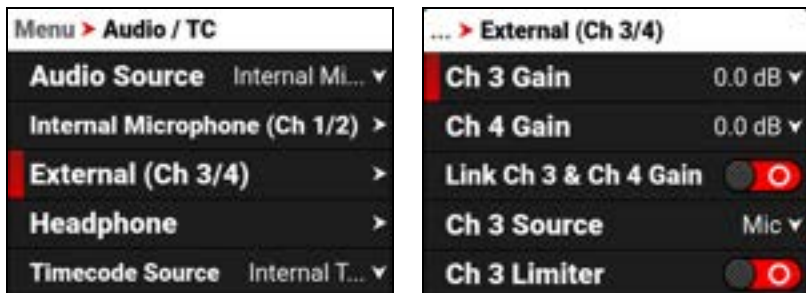

The External audio is represented as Channels 3 and 4 on the Home Page and on the Audio Channels 3/4 Page VU Meters (refer to **LCD** for more information). The left channel is channel 3 and the right channel is channel 4.

## GAIN

You can adjust the external audio gain levels for channels 3 and 4 from -8.0 dB to 34.0 dB.



The default setting is 0 dB.

When you enable Link Channel 3 and Channel 4 Gain, the channels are linked together and adjusted as one.

## SOURCE

Use Source to select the type of input connected to external audio channel 3 and 4 ports.



You can select microphone, line, or +48V phantom power. The default setting is microphone (Mic).

## LIMITER

When enabled, use the limiter to place a limit past which the audio level for channels 3 and 4 cannot exceed.



You can select from -2.0 to -12.0 Decibel Full Scale (dBFS) as the limit. The default limit is -6.0 dBFS.

## HEADPHONE

Use the Headphone settings to enable the headphone jack and to adjust the headphone volume.

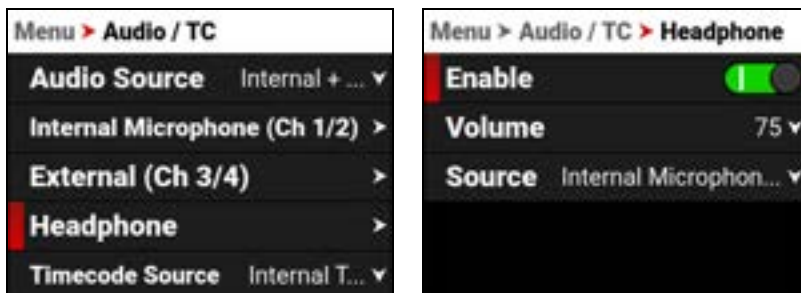

You can enable and disable the headphone audio jack by pressing SEL to toggle Enable to the right (green / enabled) and to the left (red / disabled).



## VOLUME

You can adjust the headphone volume from 0 to 100.



## SOURCE

When the Audio Source is set to Internal + External, you can use Source to select the audio source you want to monitor with the headphones.

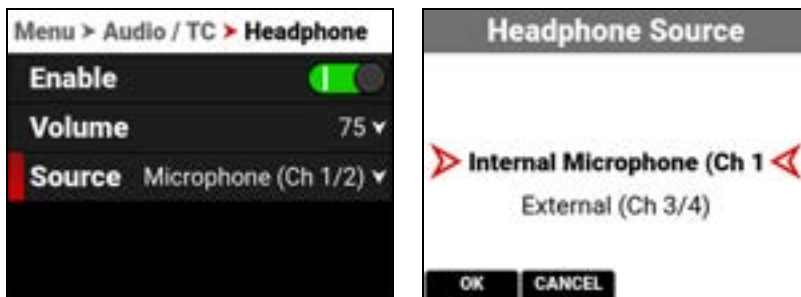

You can select the internal microphone channels 1 and 2, or you can select the external channels 3 and 4. The default setting is the internal microphone channels 1 and 2.

## TIMECODE SOURCE

Use Timecode source to configure the Timecode source the camera applies to the recordings.

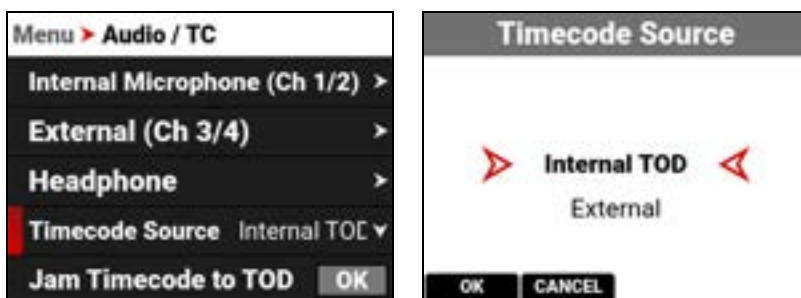

You can set the Timecode source as Internal Time of Day (TOD) or External.

When you set the camera Timecode source to External, you can connect an external Timecode generator to the Extension Port (refer to **Camera Body** and **Extension Port** for more information).

## TIMECODE DISPLAY MODE

Use Timecode Display Mode to configure the Timecode display type that the camera applies to the recordings.

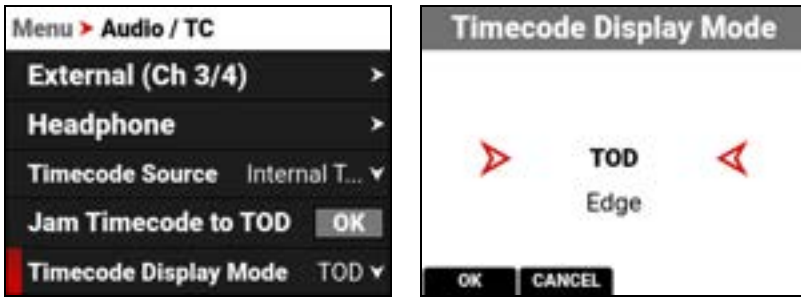

You can set the Timecode Display Mode as Time of Day (TOD) or Edge.

### TOD DISPLAY MODE

Time of Day (TOD) display mode displays the Timecode as the time of day that the frame was recorded.

### EDGE DISPLAY MODE

Edge display mode displays the Timecode as the sequential recording time that has elapsed starting with the first frame.

## MONITORING MENU

The Monitoring menu contains the settings you use to configure your camera monitoring options.

From the LCD menu, navigate to Monitoring and press SEL:

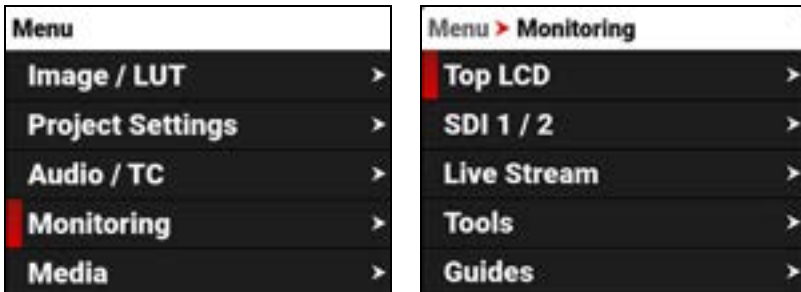

Use the Monitoring menu to configure the monitoring settings:

ITEM	DETAILS
Top LCD	Monitoring tools for the top LCD
SDI 1 / 2	SDI port resolution, frequency, look, guides, tools, overlay, and overlay mode
Live Stream	Enable or disable Wi-Fi live streaming
Tools	Various monitoring tools including <b>False Color</b> , <b>Peaking</b> , and <b>Zebra Modes</b>
Guides	Frame guides and a center guide

## TOP LCD

The Top LCD menu provides access to the top LCD features. This menu is only visible when the optional DSMC3 RED Touch 7.0" LCD is attached to the camera (refer to [DSMC3 RED® Touch 7.0" LCD](#)).

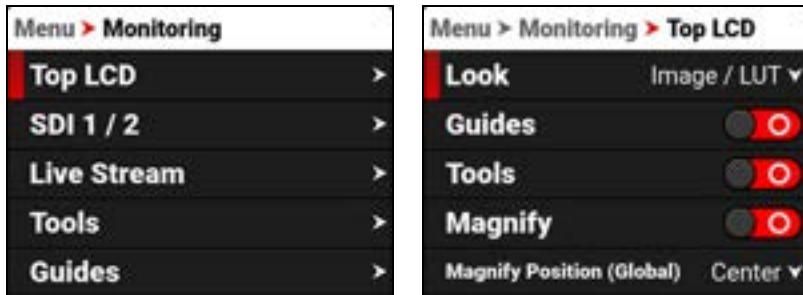

The SDI port settings you can configure include:

ITEM	DETAILS
Look	Set the look of the playback between RWG / Log3G10 or Image / LUT
Guides	Enable or disable the monitor guides
Tools	Enable or disable the monitor tools
Magnify	Magnify the monitor image
Magnify Position	Select the position of the original image to magnify
Flip / Mirror	Flip and mirror the top LCD display

## LOOK



You can select the look of the image preview signal sent to the SDI port.

The selections include:

- REDWideGamutRGB / Log3G10
- Image / LUT (default)

## GUIDES

Use Guides to enable or disable the viewing of guides. Press SEL to toggle between enabled and disabled (default).



## TOOLS

Use Tools to enable or disable the viewing of tools. Press SEL to toggle between enabled and disabled (default).



## MAGNIFY

Use Magnify to enable or disable monitor magnification. Press SEL to toggle between enabled and disabled (default).



## MAGNIFY POSITION



Use Magnify Position to globally select the area of the image you want to magnify.

The selections include:

- Left
- Upper Middle
- Upper Right
- Upper Left
- Center (default)
- Lower Right
- Lower Left
- Lower Middle
- Right

## FLIP / MIRROR

Use Flip / Mirror to enable or disable the flipped mirrored orientation of the Top LCD. Press SEL to toggle between enabled and disabled (default).



## SDI 1 / 2

Use SDI 1 / 2 to configure the settings on SDI ports 1 and 2.



The SDI port settings you can configure include:

ITEM	DETAILS
Frequency	Select the SDI port frequency
Resolution	Select the SDI port resolution
Display Preset	Select the gamma for the camera preview and monitor output
Look	Set the look of the playback between RWG / Log3G10 or Image / LUT
Guides	Enable or disable the monitor guides
Tools	Enable or disable the monitor tools
Overlay	Enable or disable the monitor overlay
Overlay Mode	Select the overlay type

**WARNING:** Under certain circumstances, it is possible for an SDI connector to incur damage when connected to an accessory and powered without using shielded cables. RED recommends only using high quality, shielded BNC cables that are rated for 12G-SDI signals and only using shielded power cables for powering SDI accessories.

Make sure power is connected to the SDI accessory at all times before you connect the BNC to the camera. Ungrounded power from SDI accessories can damage the camera's SDI port. To avoid this possible damage, attach the power source to the accessory before attaching it to the BNC cable. When using RED Approved Third Party battery plates, unplug the BNC cable prior to hot swapping.

When possible, avoid using P-Tap (also known as D-Tap) cables to power accessories. To avoid damage when using P-Tap/D-Tap, it's imperative that the connect/disconnect sequence (below) is followed precisely.

## BNC ATTACHMENT INSTRUCTIONS

When attaching SDI accessories:

1. Connect a power source to the SDI accessory; power on the SDI accessory.
2. Ensure a power source is connected to the camera. This ensures both are grounded prior to connecting the BNC. The camera's power state does not have an impact on SDI attachment sequence.
3. Connect the BNC cable to the accessory, then to the camera.

When detaching an accessory mounted to an SDI output, ensure that you remove the BNC connection to the camera before removing power to the SDI device:

1. Shutdown the SDI accessory.
2. Disconnect the BNC cable from the camera.
3. Disconnect the power source from the SDI accessory.

When you need to swap out a battery on an accessory mounted to the camera's SDI port, you must:

1. Shutdown the SDI accessory.
2. Disconnect the BNC cable from the camera.
3. Replace the battery on the SDI accessory.
4. Connect the BNC cable to the camera.
5. Power on the SDI accessory.

For more information, refer to [Preventing Damage to SDI Outputs](#).

## FREQUENCY

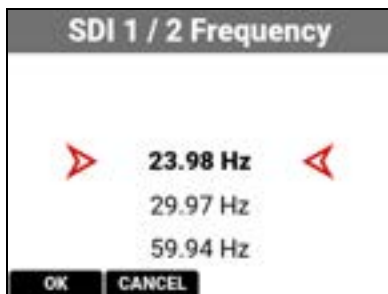

Use Frequency to select one of the following SDI port frequency settings:

- 23.98 Hz
- 29.97 Hz
- 59.94 Hz

## RESOLUTION



Use resolution to select one of the following SDI port resolution settings:

- 1080p
- 2K DCI
- 4K UHD
- 4K DCI

The resolution selected here controls the SDI output resolution of the preview page.

## SCALING PREVIEW

When monitoring in 1080p or 4K UHD while capturing in a 17:9 format, the entire 17:9 image will be down-scaled to the 16:9 aspect ratio of 1080p or 4K UHD. Small black bars will only appear on the top and bottom of the frame in the monitor path and not on the recorded image.

## DISPLAY PRESET



Use Display Preset to select gamma of the displayed preview image for the SDI ports:

- SDR - **Standard Dynamic Range** (default)
- HDR - **High Dynamic Range**
- HLG - **Hybrid Log-Gamma**

When shooting in R3D format, the camera stores this as metadata, which you can adjust non-destructively in post production after filming.

The Display Preset allows you to select the gamma for the camera preview and monitor output.

Each monitor is designed to display using a specific gamma. Most monitors use SDR. However, some support HDR and HLG gamma signals. Select the display preset that works best with your monitor.

## LOOK



You can select the look of the image preview signal sent to the SDI port.

The selections include:

- REDWideGamutRGB / Log3G10
- Image / LUT (default)

## GUIDES

Use Guides to enable or disable the viewing of guides. You can enable and disable guides by pressing SEL to toggle Guides to the right (green / enabled) and to the left (red / disabled).





## TOOLS

Use Tools to enable or disable the viewing of tools. You can enable and disable tools by pressing SEL to toggle Tools to the right (green / enabled) and to the left (red / disabled).



## OVERLAY

Use Overlay to enable or disable the viewing of the overlay. You can enable and disable the overlay by pressing SEL to toggle Overlay to the right (green / enabled) and to the left (red / disabled).



## OVERLAY MODE



Use Overlay Mode to select one of the following SDI port overlay modes:

- Simple - minimal image information is displayed
- Advanced - many image and camera details are displayed

## SIMPLE MODE



Simple mode displays the clip name and the current Timecode. When the camera is recording, the Timecode turns red, and a red dot appears in the top right corner.



## ADVANCED MODE



Advanced mode displays the following:

TOP	BOTTOM
<ul style="list-style-type: none"> <li>• Camera Number</li> <li>• Recording Frame Rate</li> <li>• f-Stop</li> <li>• Focus Length</li> <li>• Shutter Angle</li> <li>• ISO</li> <li>• White Balance</li> </ul>	<ul style="list-style-type: none"> <li>• Clip Name</li> <li>• Exposure Meter</li> <li>• Histogram</li> <li>• CFexpress Time Remaining</li> <li>• Temp / Exp Calibration</li> <li>• Timecode, Genlock, Synch</li> <li>• DC-In, Battery</li> <li>• Format, File Type, Rate</li> <li>• VU Meter</li> <li>• Timecode</li> </ul>

When the camera is recording, the Timecode turns red, and a red dot appears in the top right corner.



## SDI PORT DESCRIPTION

The Serial Digital Interface (SDI) ports allow the camera to deliver 12 Gbps of image bandwidth with greater resolution, frame rates, and color fidelity. These ports allow you to use a single BNC cable solution ideal for 4Kp60 format.

**WARNING:** Under certain circumstances, it is possible for an SDI connector to incur damage when connected to an accessory and powered without using shielded cables. RED recommends only using high quality, shielded BNC cables that are rated for 12G-SDI signals and only using shielded power cables for powering SDI accessories.

Make sure power is connected to the SDI accessory at all times before you connect the BNC to the camera. Ungrounded power from SDI accessories can damage the camera's SDI port. To avoid this possible damage, attach the power source to the accessory before attaching it to the BNC cable. When using RED Approved Third Party battery plates, unplug the BNC cable prior to hot swapping.

When possible, avoid using P-Tap (also known as D-Tap) cables to power accessories. To avoid damage when using P-Tap/D-Tap, it's imperative that the connect/disconnect sequence (below) is followed precisely.

## BNC ATTACHMENT INSTRUCTIONS

When attaching SDI accessories:

1. Connect a power source to the SDI accessory; power on the SDI accessory.
2. Ensure a power source is connected to the camera. This ensures both are grounded prior to connecting the BNC. The camera's power state does not have an impact on SDI attachment sequence.
3. Connect the BNC cable to the accessory, then to the camera.

When detaching an accessory mounted to an SDI output, ensure that you remove the BNC connection to the camera before removing power to the SDI device:

1. Shutdown the SDI accessory.
2. Disconnect the BNC cable from the camera.
3. Disconnect the power source from the SDI accessory.

When you need to swap out a battery on an accessory mounted to the camera's SDI port, you must:

1. Shutdown the SDI accessory.
2. Disconnect the BNC cable from the camera.
3. Replace the battery on the SDI accessory.
4. Connect the BNC cable to the camera.
5. Power on the SDI accessory.

For more information, refer to [Preventing Damage to SDI Outputs](#).



For more information, refer to:

- [12G-SDI \(SDI-1 & SDI-2\)](#)
- The SDI standard: SMPTE (Society of Motion Picture and Television Engineers) standard SMPTE ST-2082

## STANDARD DYNAMIC RANGE

Standard-dynamic-range (SDR) video describes images or video using a conventional gamma curve signal.

## HIGH DYNAMIC RANGE

High-dynamic-range (HDR) video images are recorded using the SMPTE-2084 PQ curve. This technology captures and outputs a greater range of luminance than images recorded using standard-dynamic-range (SDR) methods.

## HYBRID LOG-GAMMA

Hybrid log-gamma (HLG) delivers HDR resolution without the need for metadata. This allows HLG to display well on SDR and HDR monitors.

## BACKGROUND

NHK and the BBC developed HLG in a joint effort to create a more compatible signal for a wide variety of television sets.

Hybrid log-gamma is an open-source standard HDR (high-dynamic-range) video format. Video dynamic range is the measurement between the brightness between black and white (luminosity).

Many monitors offer HDR. However, unlike resolution parameters (1080p, 4K, etc.), HDR is related to luminosity. Luminosity can vary between how an image is captured on a camera and how the image is broadcast to a monitor.

HLG sends a combination (hybrid) of the normal Gamma curve for light coding and a logarithmic curve to deliver the HDR aspects of the signal.

## LIVE STREAM

Use Live Stream to enable or disable live streaming over Wi-Fi. This is one of the methods you can use to connect to the [RED Control App](#).

**NOTE:** When live streaming, select 5 GHz as the Wi-Fi band (refer to [Ad-Hoc](#)).

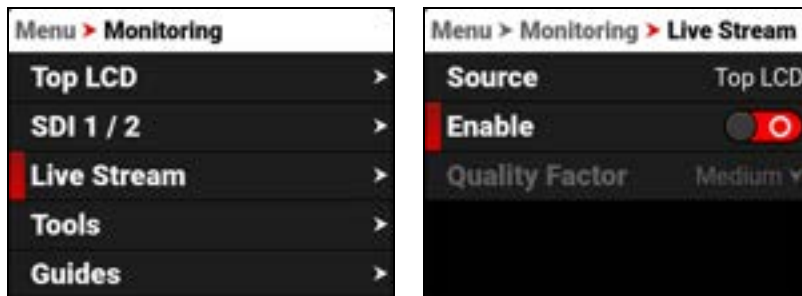

## SOURCE

Source displays the source of the Live Stream image. Live stream displays the guides, looks, and tools enabled for that source.



## ENABLE

Use Enable to enable or disable the Live Stream feature.

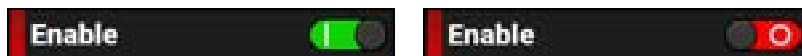

## QUALITY FACTOR

Use Quality Factor, when Live Streaming is enabled, to control the video quality the camera's output streams. Lower quality can stream over a longer distance.

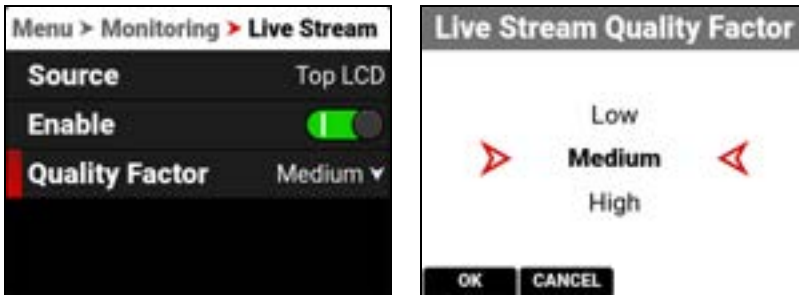

## TOOLS

The Tools menu provides access to the monitoring tools you use to monitor image exposure and focus.



The monitoring tools that you can use include:

ITEM	DETAILS
False Color	Enable and configure the <b>False Color Exposure Mode</b> and the <b>False Color Video Mode</b>
Peaking	Enable and configure focus indicating modes
Log View	Enable or Disable Log View
Zebra 1	Enable and configure Zebra 1 settings
Zebra 2	Enable and configure Zebra 2 settings

## FALSE COLOR

Use False Color to configure the False Color tool settings.

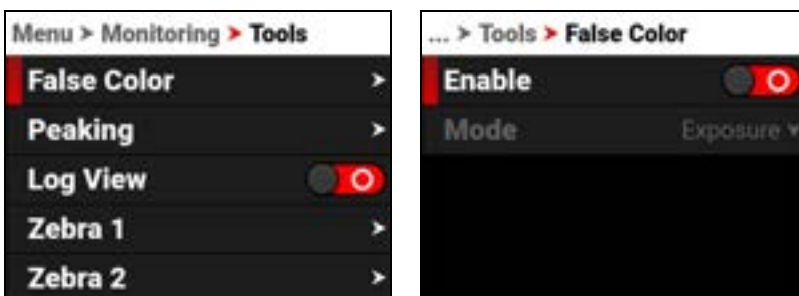



The False Color tool settings you can configure include:

ITEM	DETAILS
Enable	Enable or disable the False Color tool modes
False Color Mode	Select the False Color tool mode

## ENABLE

Use Enable to enable or disable the False Color tool.

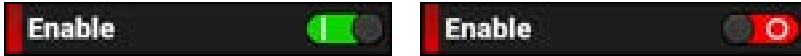

## FALSE COLOR MODE

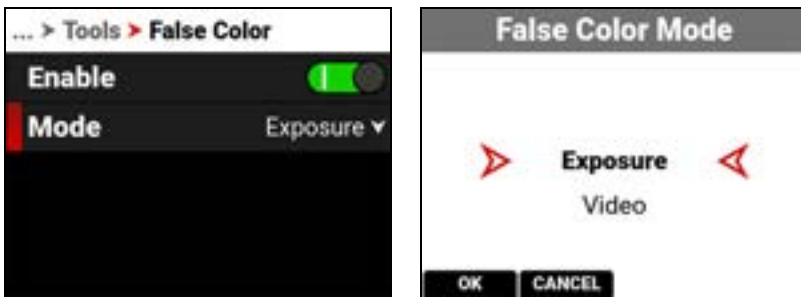

False Color Modes include:

ITEM	DETAILS
False Color Exposure Mode	Use false colors to determine an optimal balance between overexposure and underexposure.
False Color Video Mode	Access scene exposure in varying light without relying on the LCD image brightness.

**NOTE:** False Color modes display on video recorded through SDI to an external recorder when the Tools are enabled in the Monitor menu. When recording through SDI, use False Color modes only to help determine scene exposure settings, and then disable the mode before recording.

## FALSE COLOR EXPOSURE MODE

When this monitoring **False Color** mode is activated, most of the tonal range will appear in monochrome.

The Exposure Mode is able to indicate exactly where middle gray is falling, and indicate which highlights or shadows are problematic in the logarithmic representation of the image. Exposure mode is judging the exposure after ISO and White Balance adjustments are made, and before any sort of LUT or transform is applied to the Log3G10 image.

## RED FALSE COLOR OVERLAY

When the False Color Mode overlays the color red within the subject of interest, or anywhere except bright lights and direct reflections, then the image is likely overexposed. When the False Color Mode does not overlay the color red on the image, then the exposure is likely okay for the selected ISO.

## PURPLE FALSE COLOR OVERLAY

When the False Color Mode overlays the color purple on key image detail that is not located in the shadows, then the scene is likely underexposed. When the False Color Mode does not overlay the color purple on the image, then the exposure is likely okay for the selected ISO.

For more information, refer to **Exposure** in the How To section.

## FALSE COLOR VIDEO MODE

**NOTE:** For best results, Video Mode should be viewed at or above ISO 800.

Video Mode displays a color overlay that indicates the video level of the RGB monitor path (calibrated to the SMPTE test signal).

The colors used are based on the RGB levels of the video out signal (that is, the “cooked” look, and not RAW data). The camera's RGB settings can change the appearance of the Video Mode colors.

The Video Mode colors represent the following IRE values (at all other values, the desaturated image represents the luminance value of the ISO adjusted image):

- Purple: IRE 0–4
- Blue: IRE 5
- Teal: IRE 10–12
- Green: IRE 41–48
- Pink: IRE 61–70
- Straw: IRE 92–93
- Yellow: IRE 94–95
- Orange: IRE 96–98
- Red: IRE 99–100

For more information, refer to [Exposure](#) in the How To section.



Green is where you will want 18% gray, Pink is typically the brightness of Caucasian skin tones, Straw, Yellow, and Orange are strong highlights and increasingly closer to white, Teal is deep shadows and Blue is on the verge of becoming untextured black. In general, Pink and Green are most helpful when calibrating based on a known reference, whereas the other colors indicate the extremes of a tonal range.

A potential disadvantage of False Color Video mode is that all the false colors can distract from the underlying preview. Many prefer to use this mode only during initial set-up, and then they use [False Color Exposure Mode](#) under a wider range of scenarios.

## IN PRACTICE

In [False Color Exposure Mode](#), use the purple and red indicators to adjust your lighting or lens aperture. Use this strategy to achieve an optimal balance between clipping from overexposure and image noise from underexposure. With most scenes, you can often have a surprising range of exposure latitude before excessive red or purple indicators begin to appear.

If necessary, use False Color Video mode or [Zebra Modes](#) to fine-tune how the scene will appear over SDI, or use it to adjust your suggested look when sending footage for post-production.

The Zebra and Video modes are also an objective way to assess the scene exposure under varying ambient light without relying on the LCD image to evaluate brightness.

## PEAKING

The Peaking tools display contrast, outlines, or colors to assist with focusing.

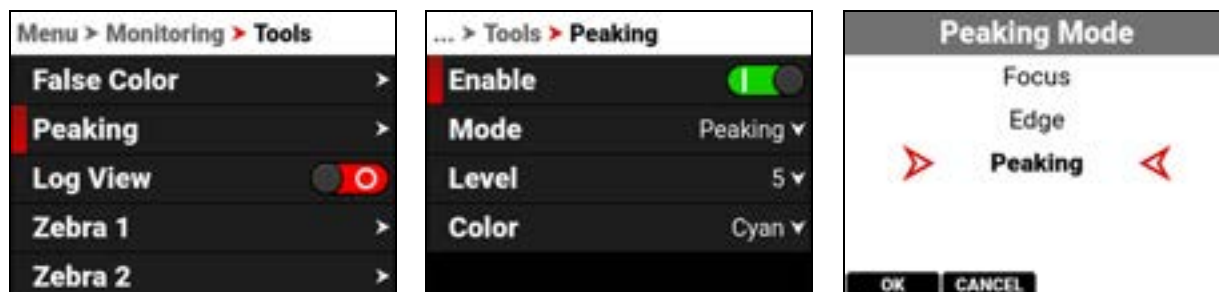



The Peaking modes you can use include:

ITEM	DETAILS
Focus	Use enhanced contrast and edges for focusing
Edge	Show outlines of focused objects
Peaking	Select a colored overlay to indicate objects in focus

## FOCUS PEAKING MODE

Focus Peaking mode emphasizes contrast and edges in the image without changing the brightness or the image content. This mode makes it easier to judge focus. Adjust the zoom and focus to easily see which objects are coming into focus.

## EDGE PEAKING MODE

When you enable Edge Peaking mode, the display shows the edges or outlines of objects that are in focus.

## PEAKING PEAKING MODE

The Peaking Peaking mode displays a color overlay on top of in-focus edges. Select a Level of 1 to 10 (weak to strong) for the intensity of the color overlay. The RGB settings can change the appearance of the selected color overlay.

The Peaking Peaking mode indicator is applied after the image is scaled to a monitor, making the indicators appear differently on various monitors.

For more information about Peaking, refer to [Focus](#) in the How To section.

## LOG VIEW

Use Log View to display camera images in REDWideGamutRGB and Log3G10 for the ISO, Exposure Adjust, Color Temperature, and Tint settings. This allows you to quickly see ungraded footage that remains unaffected by creative decisions such as the choice of 3D LUT or CDL.

Log View is passed through the SDI port when recording to an external recorder. You can view the Log image in playback on the LCD and on the monitor. However, Log View is not recorded to the file on the media card.

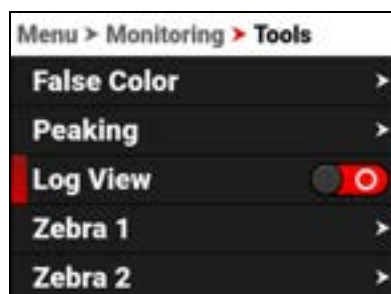

Press SEL to toggle the Log View switch between Enabled and Disabled:



## ZEBRA 1

Use Zebra 1 to display one set of diagonal stripes to indicate highlight exposure levels. For more information, refer to [Zebra Modes](#).

Zebra 1 is disabled by default.

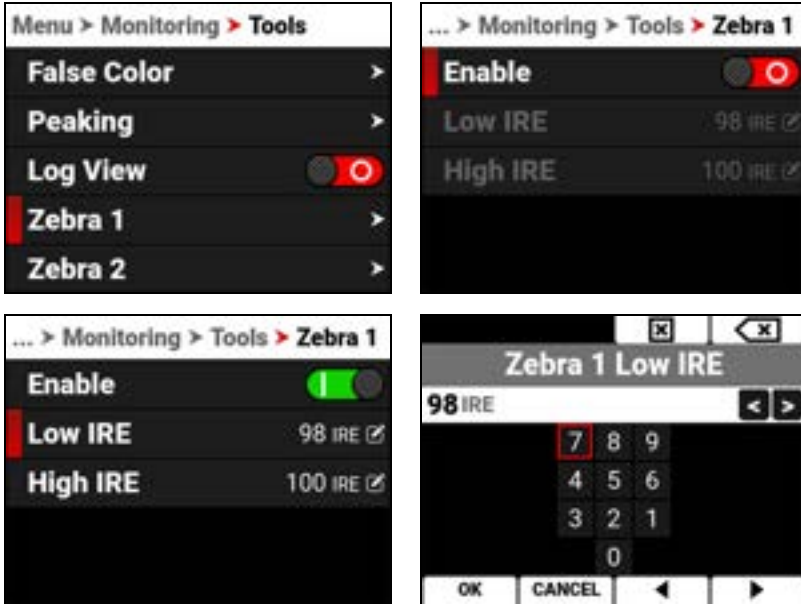

The Zebra 1 mode includes:

ITEM	DETAILS
Enable	Enables red zebra stripes to indicate highlight exposure
Low IRE	Sets the lower threshold for the indicator
High IRE	Sets the higher threshold for the indicator

## ENABLE

The Enable toggle switch allows you to enable or disable the Zebra 1 stripes.

## LOW IRE

Provides a keypad that allows you to set the low threshold for the Zebra stripe. The default setting is 98 IRE.

## HIGH IRE

Provides a keypad that allows you to set the high threshold for the Zebra stripe. The default setting is 100 IRE.

## NORMAL VIEW



## ZEBRA 1 VIEW



## ZEBRA 2

Use Zebra 2 to display a second set of diagonal stripes to indicate mid-tone and shadow levels. For more information, refer to [Zebra Modes](#).

Zebra 2 is disabled by default.

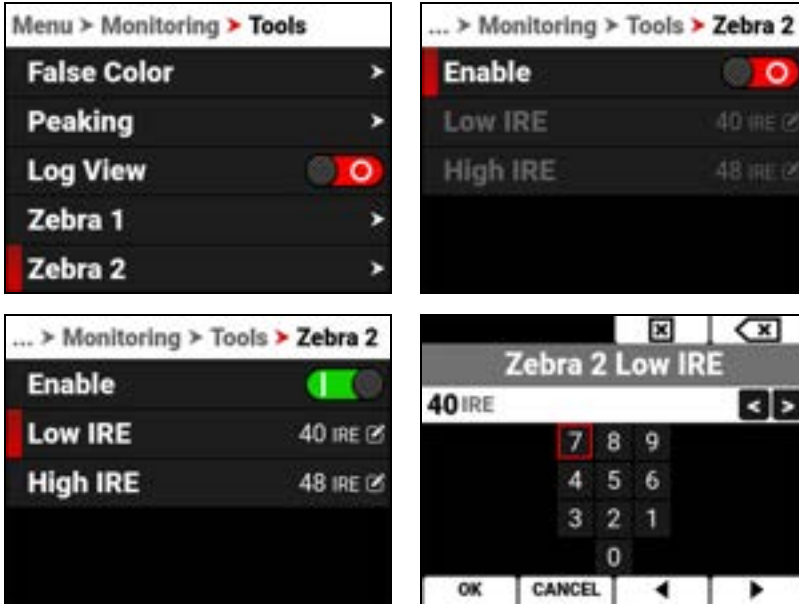

The Zebra 2 mode includes:

ITEM	DETAILS
Enable	Enables green zebra stripes to indicate mid-tone and shadow exposure
Low IRE	Sets the lower threshold for the indicator
High IRE	Sets the higher threshold for the indicator

### ENABLE

The Enable toggle switch allows you to enable or disable the Zebra 2 stripes.

### LOW IRE

Provides a keypad that allows you to set the low threshold for the Zebra stripe. The default setting is 40 IRE.

### HIGH IRE

Provides a keypad that allows you to set the high threshold for the Zebra stripe. The default setting is 48 IRE.

### NORMAL VIEW

### ZEBRA 1 VIEW

### ZEBRA 2 VIEW



## GUIDES

Use Guides to enable and configure the camera's monitoring guides.

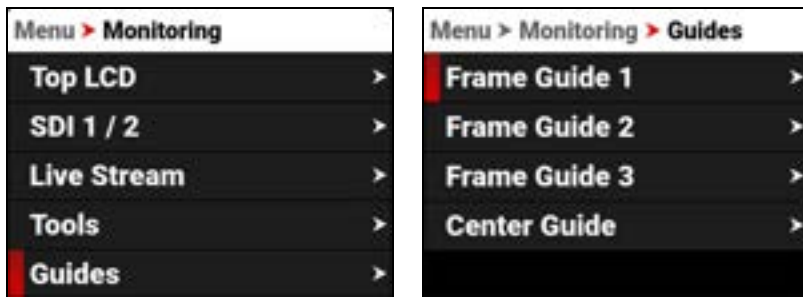

The monitoring Guides that you can use include:

ITEM	DETAILS
Frame Guides	Guides you can configure to aid in framing a shot
Center Guide	A center cross hair or dot you can use to center your shot

## FRAME GUIDES

Use Frame Guides to frame the scene using various shapes and sizes. You can configure up to 3 Frame Guides to display on your monitor.

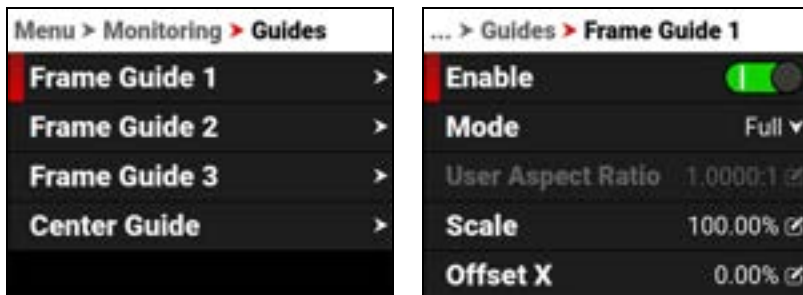

Configure the Frame Guides using the following:

ITEM	DETAILS
Enable	Enables the Frame Guide
Mode	Select aspect ratios, User, and Absolute modes
User Aspect Ratio	Enabled by selecting User mode
Scale	Percentage of the image the Frame Guide occupies
Offset X, Y	Percentage of horizontal and vertical offset
Absolute X, Y, W, H	Absolute mode - set the exact number of size and offset pixels
Line Style	Select the Frame Guide line type - solid, dashed or bracket
Line Color	Select the Frame Guide line color
Line Opacity	Select the Frame Guide line opacity
Shade Outside	Enables shading outside of the Frame Guide
Shade Color	Select the shading color
Shade Opacity	Select the shading opacity

## MODE

Use Mode to select the Frame Guide mode you want to use to configure the frame guide.

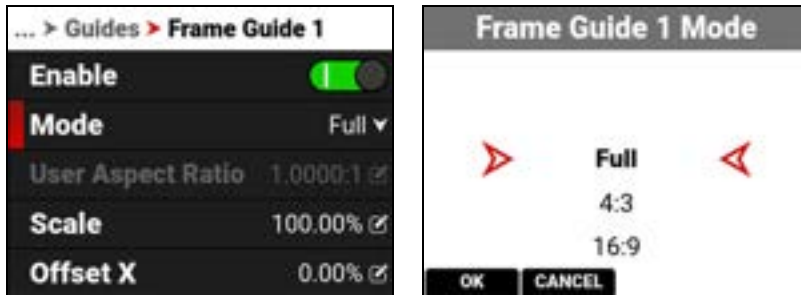

The modes you can select include aspect ratios from Full to 2.4:1, User, and Absolute. The User and Absolute modes enable settings that are specific to those modes.

## USER ASPECT RATIO

This item is enabled when the User mode is selected.

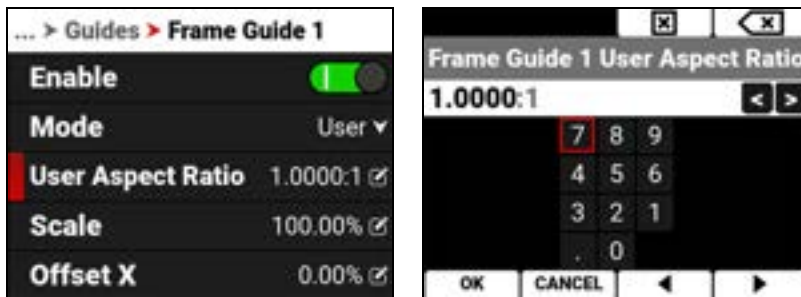

Use the keypad to enter your desired aspect ratio.

## SCALE

Use scale to configure the percentage of the image area that the Frame Guide will frame.

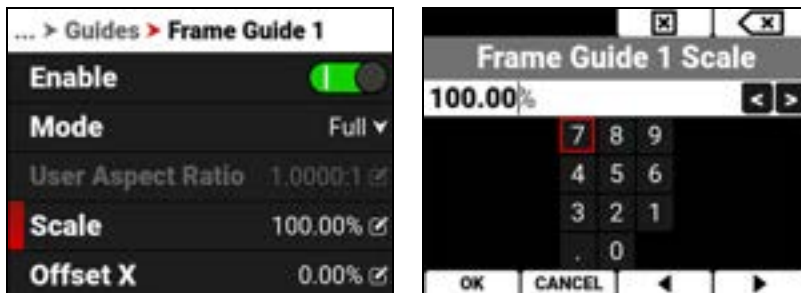

Use the keypad to enter the percentage of the image the Frame Guide contains.

## OFFSET X, Y

Use offset to configure the X and Y offset of the Frame Guide.

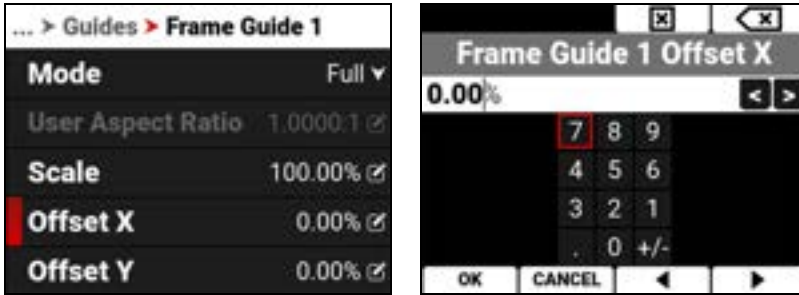

Use the keypad to enter the percentage of offset from center you want to apply to the Frame Guide.

## ABSOLUTE X, Y, W, H

Use the Absolute settings to configure the absolute dimensions and position of the Frame Guide.

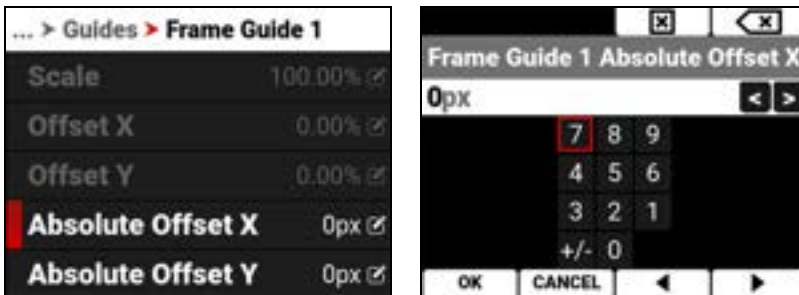

Use the keypad to enter the number of pixels for X/Y offset and for the width and height of the Frame Guide. The Absolute items are only enabled when you select Absolute Mode.

## LINE STYLE

Use Line Style to select the type of line the Frame Guide uses.

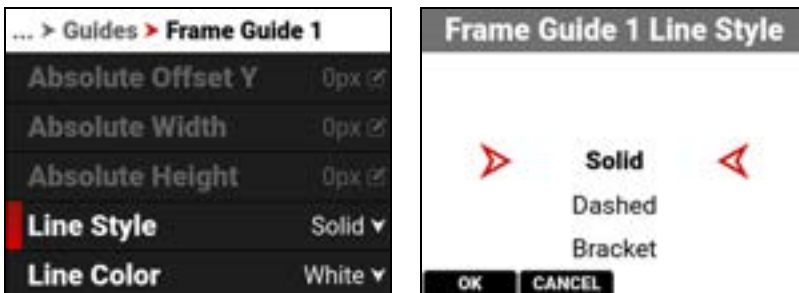

Select Solid (default), Dashed, or Bracket for the Frame Guide line style.

## LINE COLOR

Use Line Color to select the color of the Frame Guide line.

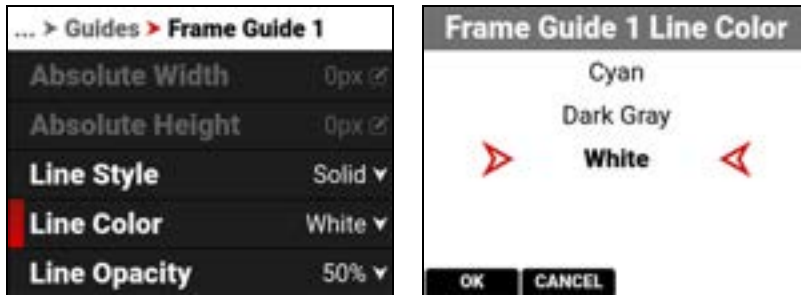

Use Line Color to select one of the following colors for the Frame Guide:

- Black
- Green
- Cyan
- Red
- Yellow
- Dark Gray
- Blue
- Magenta
- White (default)

## LINE OPACITY

Use Line Opacity to select how transparent the Frame Guide line appears.

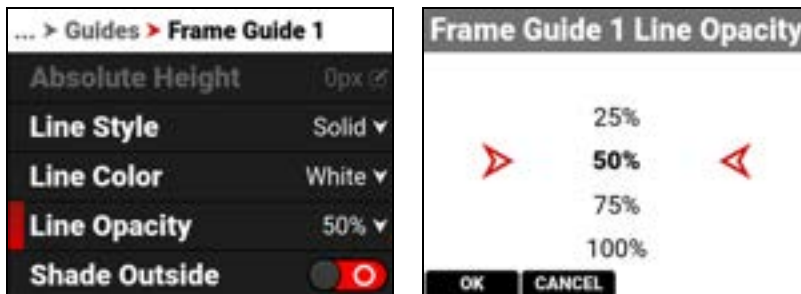

Use Line Opacity to select the percentage of opacity for the Frame Guide:

- 25%
- 50% (default)
- 75%
- 100%

## SHADE COLOR

Use Shade Color to select the color of shading to use outside of the Frame guide.

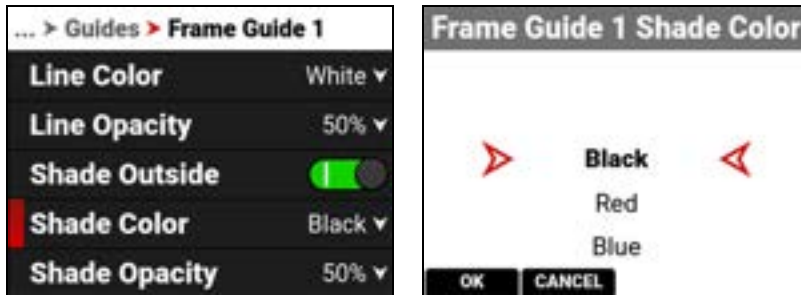

Use Shade Color to select one of the following colors for the outside shading:

- Black (default)
- Red
- Blue
- Green
- Yellow
- Magenta
- Cyan
- Dark Gray
- White

## SHADE OPACITY

Use Shade Opacity to select the opacity of the shading outside of the Frame guide.

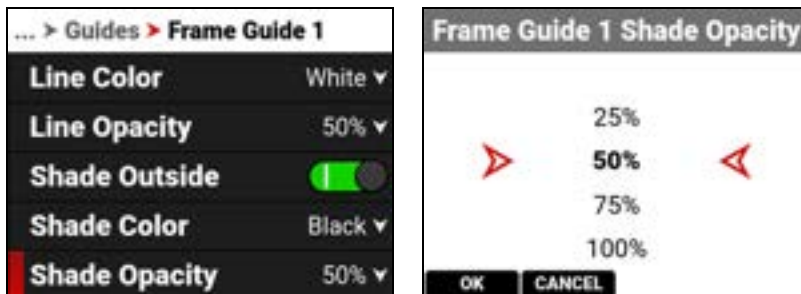

Use Shade Opacity to select the percentage of opacity for the shading outside of the Frame Guide:

- 25%
- 50% (default)
- 75%
- 100%



## CENTER GUIDE

Use Center Guide to enable and configure the Center Guide.

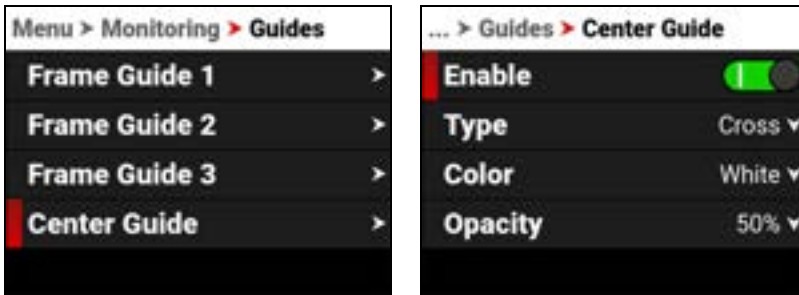

Configure the Center Guide by using the following:

ITEM	DETAILS
Enable	Enables the Center Guide
Type	Select Center Guide type - dot or cross
Color	Select a color for the Center Guide
Opacity	Percentage of opacity of the guide color

## TYPE

Use Type to select the type of Center Guide to display.

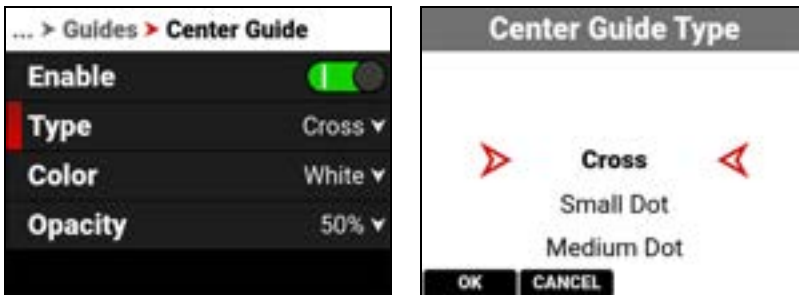

Use Type to select a center dot or cross (default) for the Center Guide.

## COLOR

Use Color to select the color used by the Center Guide.

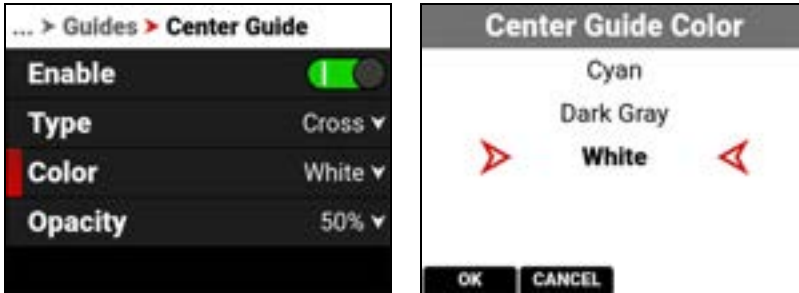

Use Color to select one of the following colors for the Center Guide:

- Black
- Green
- Cyan
- Red
- Yellow
- Dark Gray
- Blue
- Magenta
- White (default)

## OPACITY

Use Opacity to select how transparent the Center Guide appears.

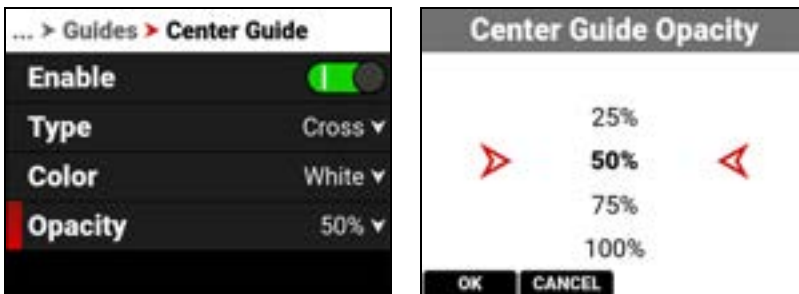

Use Opacity to select the percentage of opacity for the Center Guide:

- 25%
- 50% (default)
- 75%
- 100%

## MEDIA MENU

The Media menu contains the settings you use to configure your media.

From the camera LCD menu, navigate to Media and press SEL:

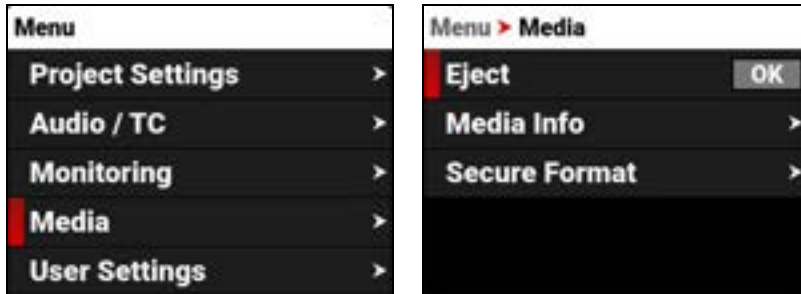

Use the Media menu to configure the camera's storage media settings and to view the media information:

ITEM	DETAILS
Eject	Eject the CFexpress media card
Media Info	View the CFexpress media card information
Secure Format	Performs a secure format of the CFexpress media card

## EJECT

Use Eject to safely eject the CFexpress media card.

**WARNING:** The media can get extremely hot. Use caution when removing media.

**WARNING:** Do not attach a label to the CFexpress media card. The heat generated by the media can weaken the label's adhesive, causing the label to detach inside of the camera. Labels can also diminish heat dissipation and cause excessive wear to the internal components. Removing a label from a CFexpress media card can possibly deform the card body.

Access Eject from the **LCD** Media menu:



For more information, refer to [Media Management](#).

## MEDIA INFO

Use Media Info to display the CFexpress media card information.

Access Media Info from the **LCD** Media menu:



Media Info displays the following:

ITEM	DETAILS
Status	Displays the CFexpress media card status
Model Number	Displays the CFexpress media card model number
Serial Number	Displays the CFexpress media card serial number
Firmware Version	Displays the CFexpress media card firmware version
Capacity	Displays the CFexpress media card total capacity
Available	Displays the CFexpress media card's remaining storage
Time Remaining	Displays the recording time remaining on the CFexpress media card

## SECURE FORMAT

Use Secure Format to format the CFexpress media card down to the file system level.

A secure format allows you to rebuild the card file system.

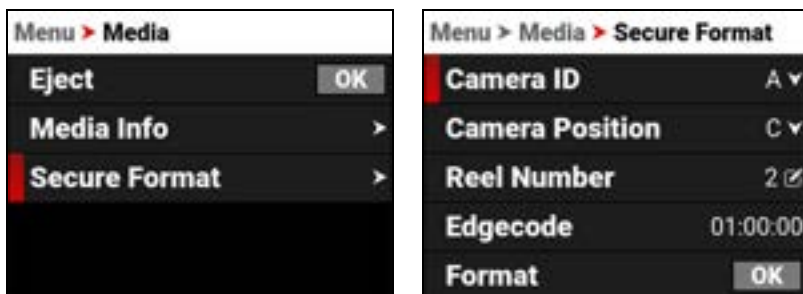

Use the Secure Format menu to update the following information:

ITEM	DETAILS
Camera ID	Select the camera ID (default is A)
Camera Position	Select the camera position (default is C)
Reel Number	Select the reel number (default is 1)
Edgecode	Enter the time number (default is 01:00:00)
Format	Starts the Secure formatting process

## CAMERA ID

Use Camera ID to assign a camera ID letter to the media.

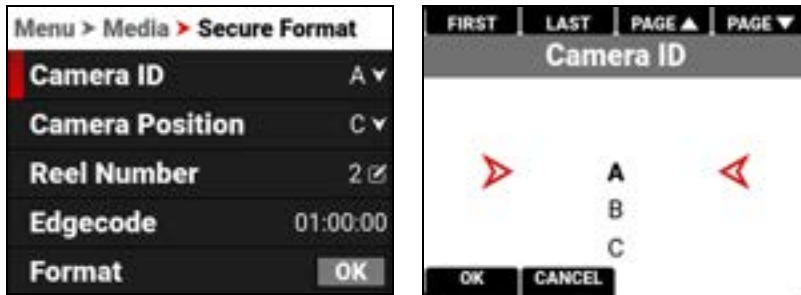

The Camera ID letters you can assign range from A-Z. For more information, refer to [Secure Format](#).

## CAMERA POSITION

Use Camera Position to select the camera position label for the CFexpress media card.

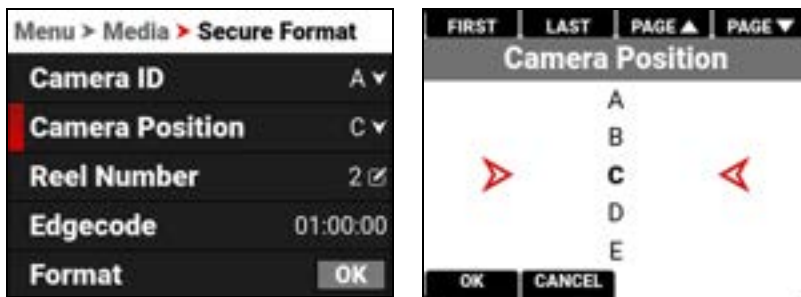

The Camera Position letters you can assign range from A-Z. For more information, refer to [Secure Format](#).

## REEL NUMBER

Use Reel Number to assign a reel number to the media.

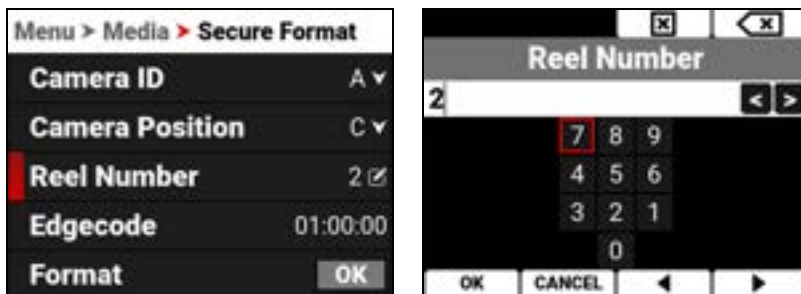

Use the keypad to enter a unique reel number to the media.

**NOTE:** It is best practice to keep your reel numbers to no longer than seven characters in length to conform with all EDL formats.

For more information, refer to [Secure Format](#).

## EDGECODE

Use Edgecode to assign an edge code to the media.

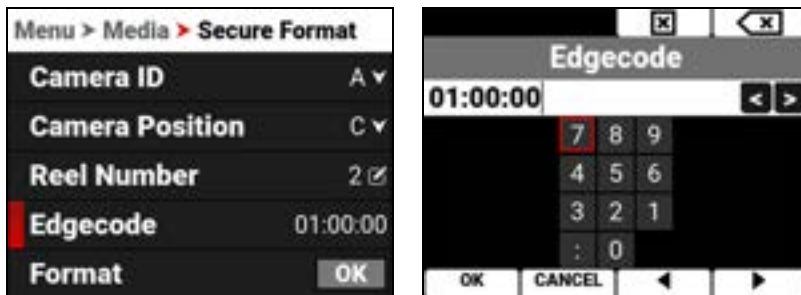

Use the keypad to enter a unique edge code number to the media.

Edge Code is a SMPTE Timecode track that by default starts at 01:00:00 on the first frame of each CFexpress media card. It is a sequential code that is continuous from frame to frame and also between clips. Edge Code is equivalent to RUN RECORD as used on broadcast cameras.

For more information, refer to [Secure Format](#).

## FORMAT

Use Format to execute a secure format of the media.

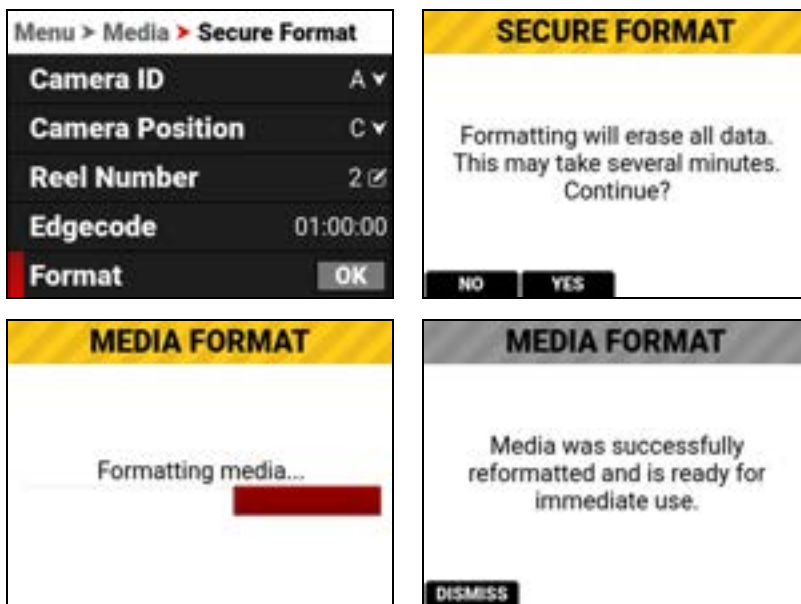

For more information, refer to [Secure Format](#).

## USER SETTINGS MENU

The User Settings menu contains the user settings you use to personalize your camera setup.

From the camera LCD menu, navigate to User Settings and press SEL:



Use the User Settings menu to build and select pre-configured settings for the camera:

ITEM	DETAILS
Presets	Create camera setting presets
Side LCD Control Panels	Enable or disable the camera LCD pages
User 1, 2, 3	Configure 8 user settings on 3 user pages

## PRESETS

The Presets menu contains the settings you use to quickly set up your camera.



Use the Presets menu to build and select pre-configured settings for the camera:

ITEM	DETAILS
Create Preset	Create camera setting presets
On Media Presets	Manage presets stored on the media
In Camera Presets	Manage presets stored in the camera

## CREATE PRESET

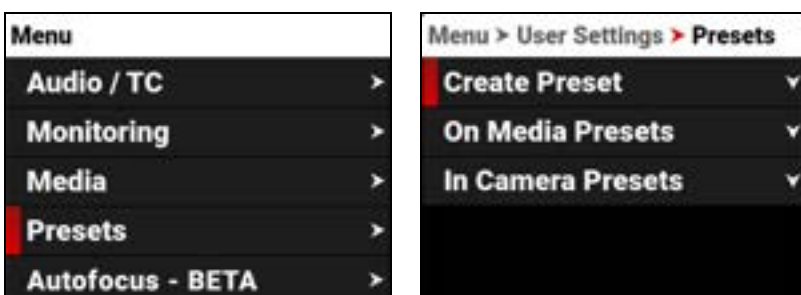

Use Create Preset to select the current camera settings you want to use to create a preset list of settings.

You can select settings individually:

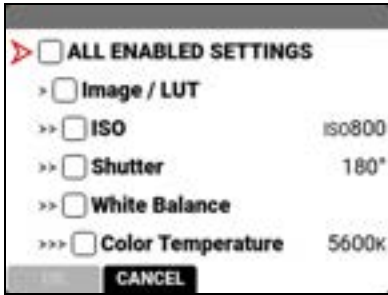

You can also use the ALL ENABLED SETTINGS checkmark button to select all of the current camera settings as a preset:

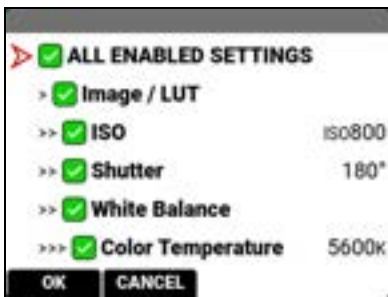

Press the button under OK to create the preset. The Preset Name screen opens.





Use the Preset Name screen to name the preset. When the name already exists in the camera, the name is highlighted in red and the OK option is grayed out:



When the name is available, press the button under OK and the confirmation screen displays:



## ON MEDIA PRESETS



You can import presets from the media to the camera. When importing presets from the media to the camera, the presets are saved to a folder on the camera called "presets."

From Media Presets, you can import the selected preset from the media to the camera or import all of the presets from the media to the camera.

## IN CAMERA PRESETS



You can export presets from the camera to the media. When exporting presets from the camera to the media, the presets are saved to a folder on the media called "presets."

From Camera Presets, you can apply the selected preset to the camera, delete the selected preset from the camera, export the selected preset from the camera to the media, or export all of the presets from the camera to the media.

## SIDE LCD CONTROL PANELS

The Side LCD Control Panels menu contains the settings you use to quickly set up your camera.

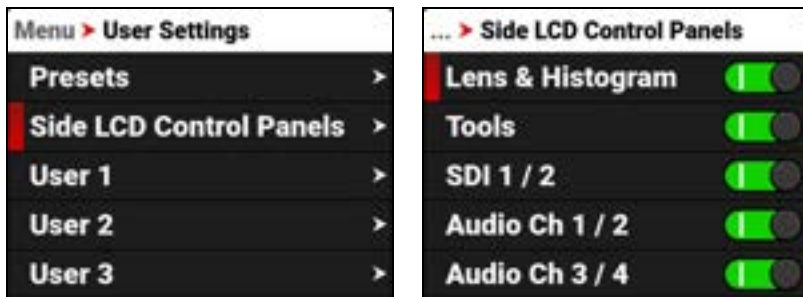

Use the Side LCD Control Panels menu to enable/disable the LCD pages.

The pages you can set include:

- Histogram Page
- Tools Page
- SDI Pages
- Audio Pages
- Headphone Panels
- User Pages

Refer to the **LCD** section for more information about the LCD pages.

## USER 1, 2, 3

The User menus contain the settings you saved to quickly configure your camera.

From the camera LCD menu, select User 1, 2, or 3:

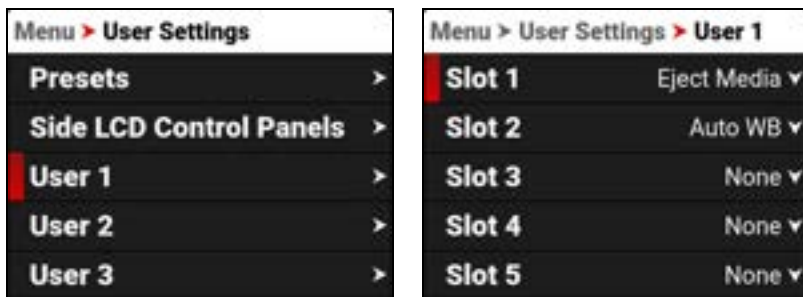

Use Slots 1-8 to assign quick user settings for the camera.



The user settings include:

<b>ITEM</b>	<b>DETAILS</b>
None	Nothing is assigned to the User Slot
Apply Preset	Apply the preset stored on the camera
Auto WB	Camera automatically adjusts the White Balance
Eject Media	Unmount the media in preparation for removal
Secure Format	Format the media
Jam TC to TOD	Jam Timecode to time of day
Start AF	Start autofocus
Save Log	Save the log file to the media
SDI 1 Magnify Toggle	SDI port 1 toggle the magnification feature on and off
SDI 2 Magnify Toggle	SDI port 2 toggle the magnification feature on and off
Top LCD Magnify Toggle	Top LCD toggle the magnification feature on and off
Pre-Record Toggle	Toggle the Pre-Record feature on and off
Pre-Record Stop	Stop the Pre-Record feature
Playback/Camera Toggle	Toggle between camera output and clip playback
Record Toggle	Toggle record on and off
False Color Toggle	Toggle the False Color tools on and off
Peaking Toggle	Toggle the Peaking tools on and off
Log View Toggle	Toggle Log view on and off
Zebra 1 Toggle	Toggle Zebra 1 on and off
Zebra 2 Toggle	Toggle Zebra 2 on and off
SDI 1 Guides Toggle	Toggle the Guides on and off on SDI 1 output
SDI 1 Tools Toggle	Toggle the Tools on and off on the SDI 1 output
SDI 1 Overlay Toggle	Toggle between the simple and advanced Overlay on the SDI 1 output
SDI 2 Guides Toggle	Toggle the Guides on and off on the SDI 2 output
SDI 2 Tools Toggle	Toggle the Tools on and off on the SDI 2 output
SDI 2 Overlay Toggle	Toggle between the simple and advanced Overlay on the SDI 2 output
Top LCD Guides Toggle	Toggle the Guides on and off on the Top LCD
Top LCD Tools Toggle	Toggle the Tools on and off on the Top LCD
Frame Guide 1 Toggle	Toggle Frame Guide 1 on and off
Frame Guide 2 Toggle	Toggle Frame Guide 2 on and off
Frame Guide 3 Toggle	Toggle Frame Guide 3 on and off
Center Guide Toggle	Toggle the Center Guide on and off
Iris Open	Open the iris
Iris Close	Close the iris
Sensor Flip Toggle	Toggle sensor flip and normal sensor

## AUTOFOCUS - BETA MENU

Use Autofocus to enable and configure the camera's Autofocus feature. The lens must support autofocus for this feature to work.

From the camera LCD menu, navigate to Autofocus - BETA and press SEL:

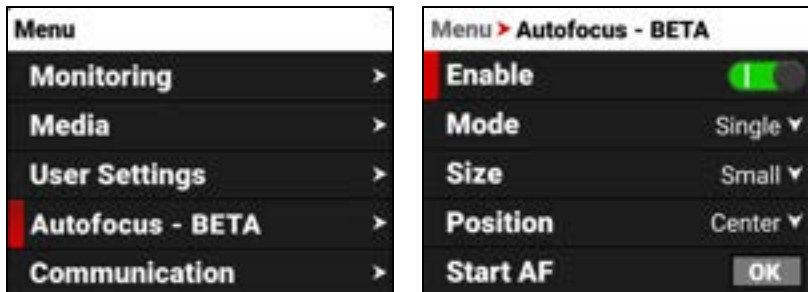

Use the Autofocus menu to perform camera autofocus tasks:

ITEM	DETAILS
Enable	Enable/Disable the autofocus feature
Mode	Select the autofocus mode
Size	Select the size of the autofocus area
Position	Select the position of the autofocus area
Start AF	Start the Autofocus feature

## ENABLE

Use Enable to enable or disable the autofocus feature. The lens must support autofocus for the camera to use this feature.

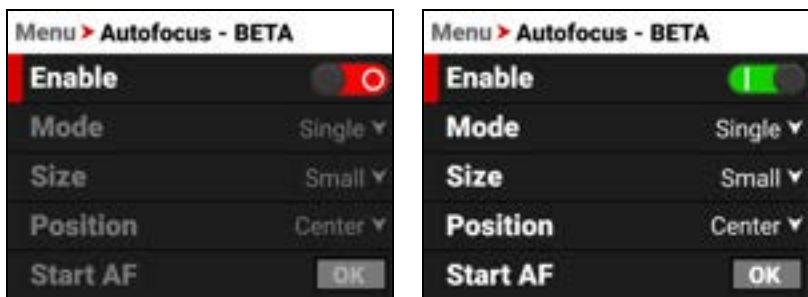

## MODE

Use Mode to select the autofocus mode for the camera. The lens must support autofocus for the camera to use this feature.

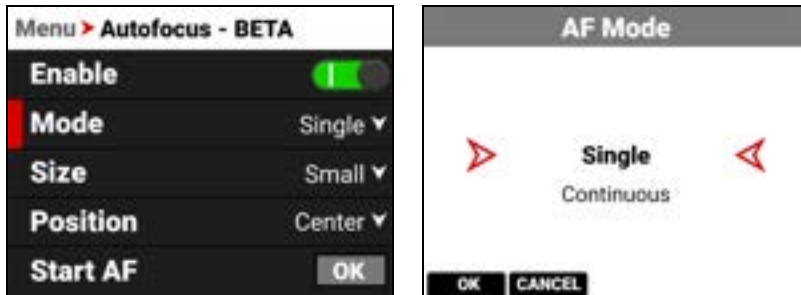

## SINGLE MODE (DEFAULT)

Use single mode to autofocus and then stop at that focus position.

## CONTINUOUS MODE

Use Continuous mode to continuously keep a moving subject in focus.

## SIZE

Use Size to choose what size area you want the camera to use for the autofocus feature. The lens must support autofocus for the camera to use this feature.

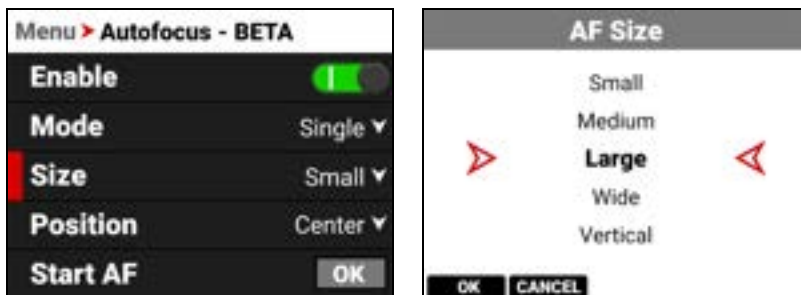

The Size selections for the autofocus area are Small (default), Medium, Large, Wide, and Vertical.

## POSITION

Use Position to specify the position of the autofocus area on the sensor. The lens must support autofocus for the camera to use this feature.

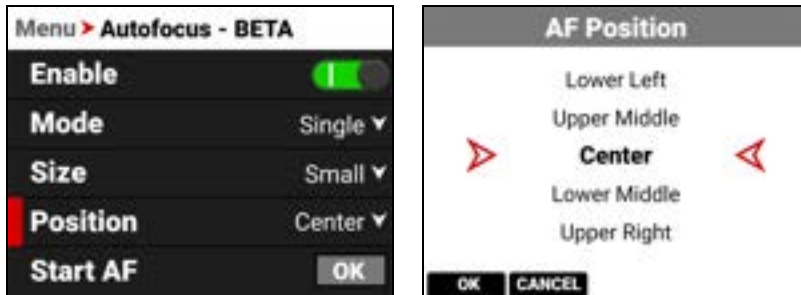

The Position selections include:

- Left
- Upper Middle
- Upper Right
- Upper Left
- Center (default)
- Lower Right
- Lower Left
- Lower Middle
- Right

The Autofocus Position rectangle displays on the monitor:

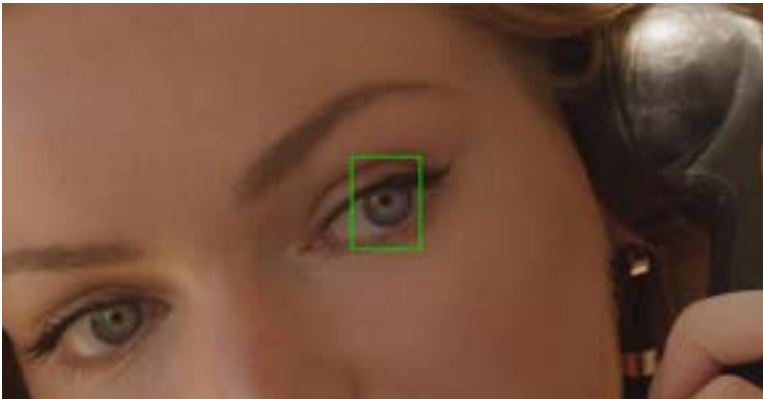

## COMMUNICATION MENU

The Communication menu contains the settings you use to configure your camera to communicate with other devices. From the camera LCD menu, navigate to Communication and press SEL:



Use the Communication menu to configure the camera's communication settings:

ITEM	DETAILS
Camera	Setting for the camera name
USB-C	Settings for USB-C communication
Wi-Fi	Settings for Wi-Fi communication
FTPS	File transfer protocol settings
Serial	Settings for the serial connection

## CAMERA

Use the Camera menu to view and edit the camera name.

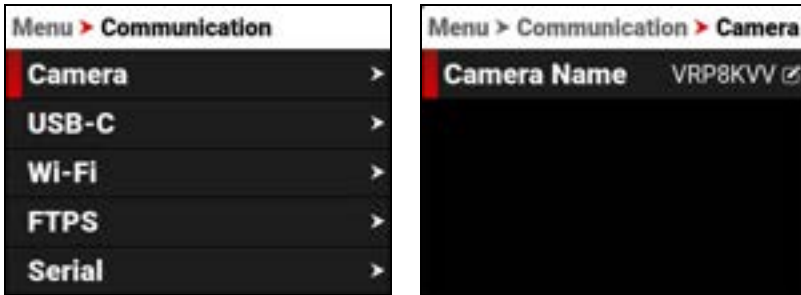

Select Camera Name to open the Camera Name editor.

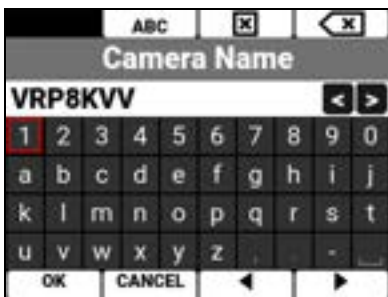

## USB-C

Use USB-C to configure the connection to the USB-C port.

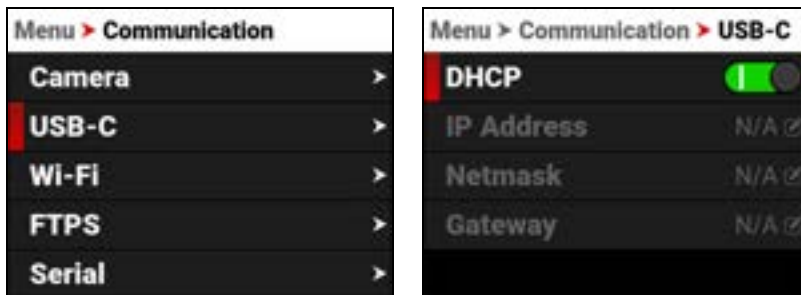

The settings you can configure for the serial connection through the Extension Port include:

ITEM	DETAILS
DHCP	Enables DHCP
IP Address	View or enter the network IP address
Netmask	View or enter the network Netmask
Gateway	View or enter the network Gateway

## DHCP

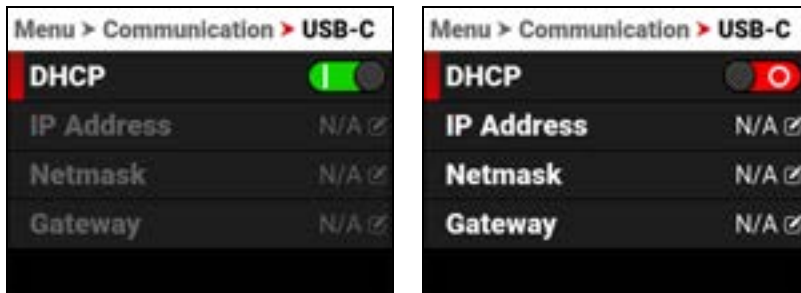

When connected to an Ethernet network, this allows you to enable or disable Dynamic Host Configuration Protocol (DHCP).



## IP ADDRESS

When connected to an Ethernet network and with DHCP enabled, IP Address displays the network IP address.



When DHCP is not enabled, you can select IP Address and manually enter a static IP address.

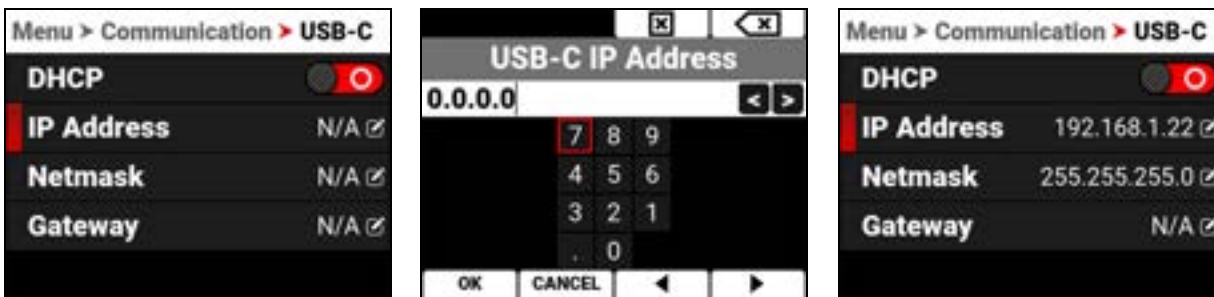

After you enter the static IP address and select OK, the Netmask entry screen opens.

## NETMASK

When connected to an Ethernet network and with DHCP enabled, Netmask displays the network Netmask address.



When DHCP is not enabled, you can select Netmask and manually enter a Netmask address. This screen opens automatically after you enter a static IP address.



## GATEWAY

When connected to an Ethernet network and with DHCP enabled, Gateway displays the network Gateway address (router address).



When DHCP is not enabled, you can select Gateway and manually enter a Gateway address.

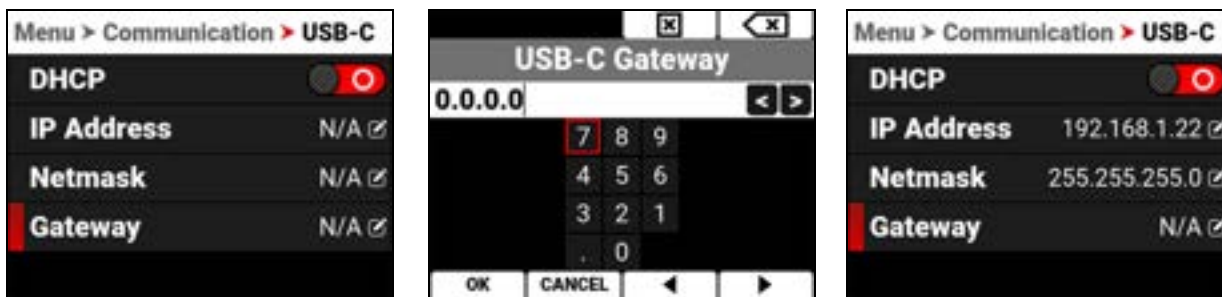

## WI-FI

Use Wi-Fi to configure the camera to work with a Wi-Fi connection.

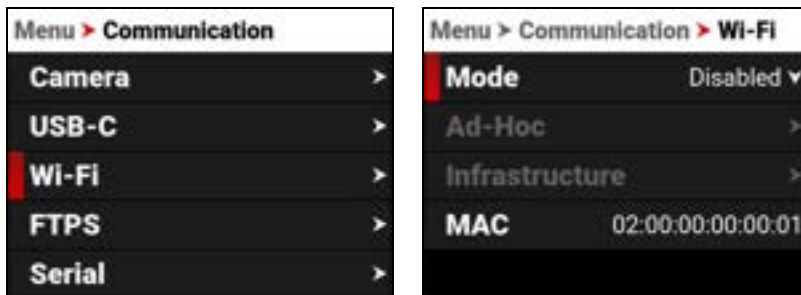

Use the Wi-Fi menu to configure the camera's Wi-Fi settings:

ITEM	DETAILS
Mode	Disable Wi-Fi or select the camera Wi-Fi settings
Ad-Hoc	Configure the camera as a Wi-Fi hot spot
Infrastructure	Settings for connecting to an existing Wi-Fi network
MAC	Displays the camera device MAC address

## MODE



From Mode you can disable the Wi-Fi network, or you can enable the camera's **Ad-Hoc** or **Infrastructure** Wi-Fi settings. The default setting is Disabled.

## AD-HOC

Use Ad-Hoc to configure the camera as a Wi-Fi hot spot.

**NOTE:** The Ad-Hoc menu is enabled when the **Wi-Fi Mode** is set to **Ad-Hoc**.



Use the Ad-Hoc menu to configure the Wi-Fi hot spot settings:

ITEM	DETAILS
SSID	Enter the name of the Wi-Fi network the camera generates
Passphrase	Enter the password for the Wi-Fi network
Band	Select the Wi-Fi frequency band
Channel	Select the optimal channel for the Wi-Fi band
Encryption	Displays the encryption type
Status	Displays the connection status
IP Address	Displays the IP address
Netmask	Displays the Netmask

## SSID

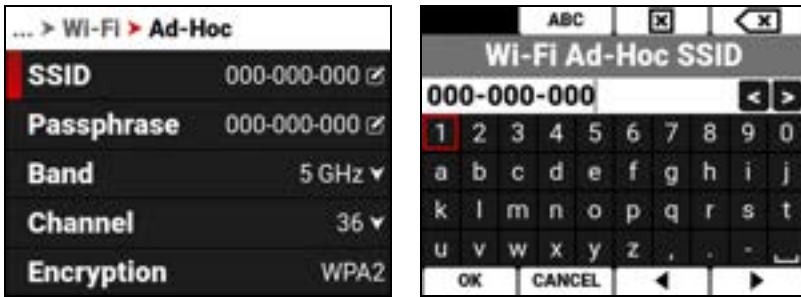

Use the keypad to enter the camera's Wi-Fi network name.

## PASSPHRASE



Use the keypad to enter the camera's Wi-Fi passphrase.

## BAND



Select the camera's Wi-Fi network frequency band.

- Use 5 GHz for optimal wireless video streaming performance (default)
- Use 2.4 GHz for long range remote control (when not utilizing wireless video streaming)

## CHANNEL



Select the optimal channel for the selected band, one which receives the least interference from the surrounding Wi-Fi signals.

## ENCRYPTION



The camera uses WPA2 security encryption.

## STATUS



Displays the camera's Ad-Hoc Wi-Fi connection status.

The Ad-Hoc status can include:

- Offline
- Online

## IP ADDRESS



When online and broadcasting a network, the camera displays an IP address.

## NETMASK



When online and broadcasting a network, the camera displays the Netmask for the IP address.

## INFRASTRUCTURE

Use Infrastructure to configure the camera to connect to an existing Wi-Fi network.

**NOTE:** The Infrastructure menu is enabled when the Wi-Fi Mode is set to **Infrastructure**. Refer to the **Wi-Fi** section for more information.



Use the Infrastructure menu to configure the Wi-Fi settings to connect to an existing Wi-Fi infrastructure:

ITEM	DETAILS
SSID	Displays the name of the connected Wi-Fi network
Networks	Scan for, select, or enter the Wi-Fi network
Status	Displays the Wi-Fi connection status
DHCP	Enable or disable DHCP
IP Address	View or enter the Wi-Fi IP address
Netmask	View or enter the Wi-Fi Netmask
Gateway	View or enter the Wi-Fi Gateway (router address)

## SSID



When a network is selected, the SSID displays the Wi-Fi network name (SSID).

## NETWORKS

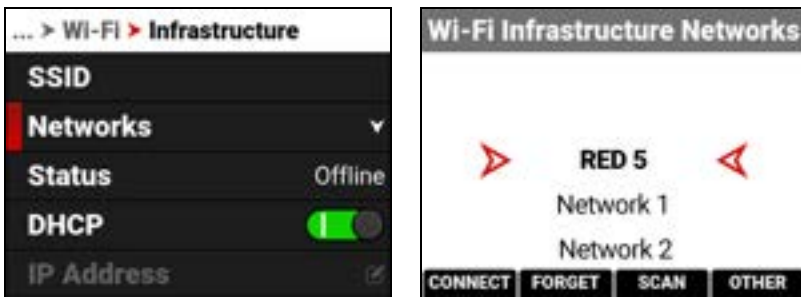

Use Networks to select an existing network, scan for an available network, or to configure a new network.

- **CONNECT:** The CONNECT button connects the camera to the selected network.
- **FORGET:** The FORGET button erases the connection information for the selected network.
- **SCAN:** The SCAN button searches for available networks.
- **OTHER:** The OTHER button opens the OTHER NETWORKS screen where you can manually enter an SSID and a Passphrase.

Select a network to open the CONNECT screen. Select Passphrase to open the Passphrase screen and enter the desired network password:

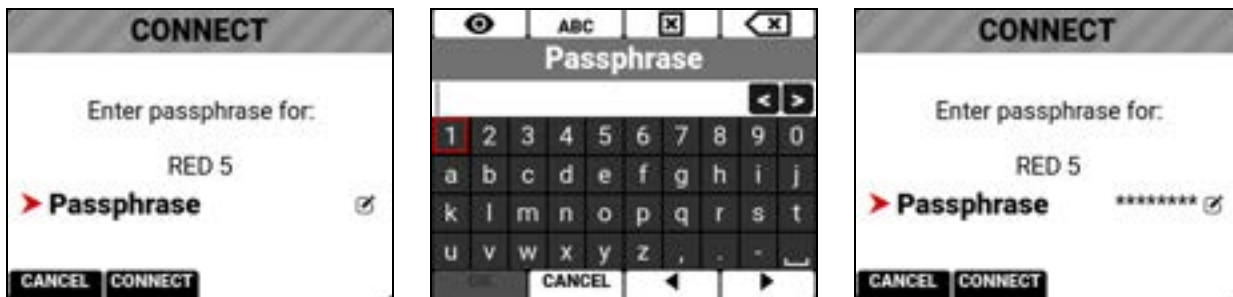

Press the button under CONNECT to connect to the new network:

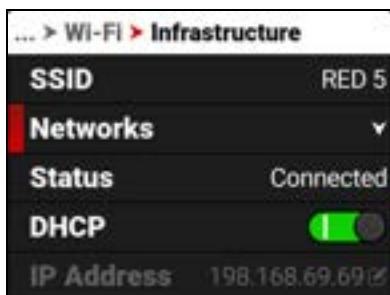



## STATUS

Displays the connection status of the camera to the selected Wi-Fi network.

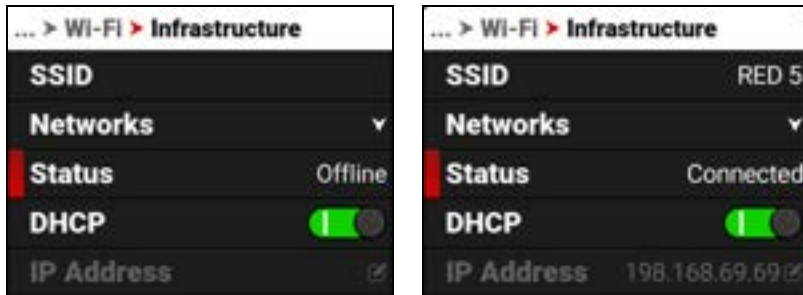

## DHCP

DHCP allows you to enable or disable Dynamic Host Configuration Protocol (DHCP).

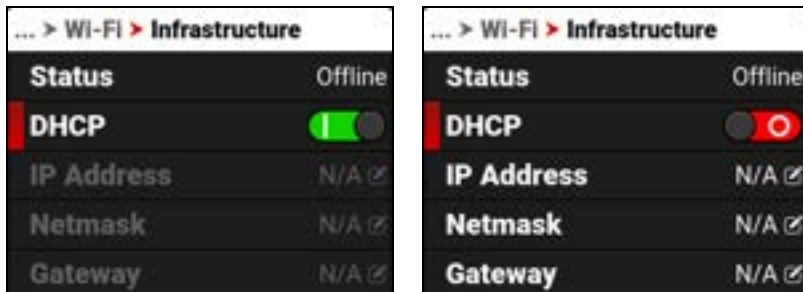

## IP ADDRESS

When connected to a Wi-Fi network and with DHCP enabled, IP Address displays the Wi-Fi network IP address.



When DHCP is not enabled, you can manually enter a static IP address.

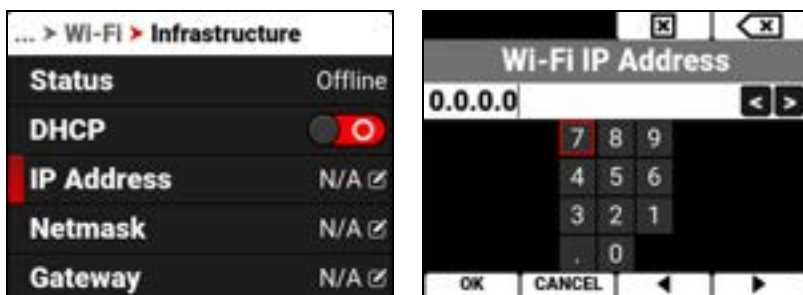

After you enter the static IP address, the Netmask entry screen opens.



## NETMASK

When connected to a Wi-Fi network and with DHCP enabled, Netmask displays the Wi-Fi network Netmask address.



When DHCP is not enabled, you can manually enter a Netmask address. This screen opens automatically after you enter a static IP address.

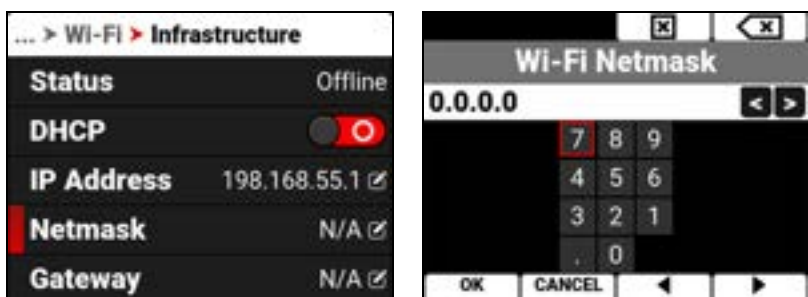

## GATEWAY

When connected to a Wi-Fi network and with DHCP enabled, Gateway displays the Wi-Fi network Gateway address (router address).



When DHCP is not enabled, you can manually enter a Gateway address.

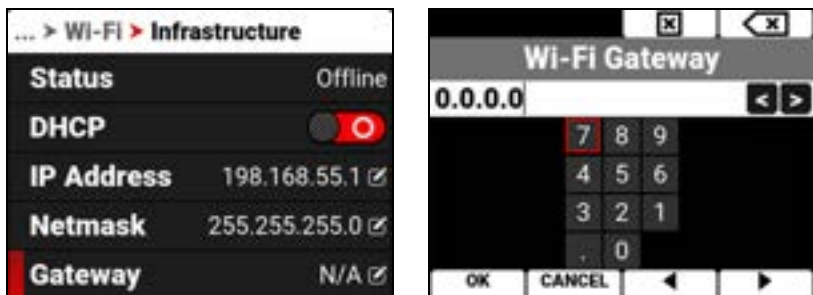

## FTPS

Use FTPS to configure the camera to work with a secure File Transfer Protocol (FTPS) connection.

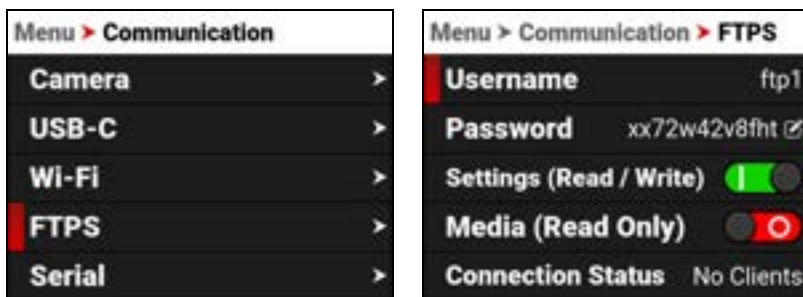

Use the FTPS menu to configure the camera's FTPS settings:

ITEM	DETAILS
Username	Static username ftp1
Password	User-editable password
Settings (R/W)	Enable FTP access to the camera settings
Media (Read Only)	Enable read-only access to the media
Connection Status	Displays the FTPS actions occurring

## PASSWORD

Use Password to enter an FTPS password. When you press SEL on Password, the FTPS Password editing screen appears.

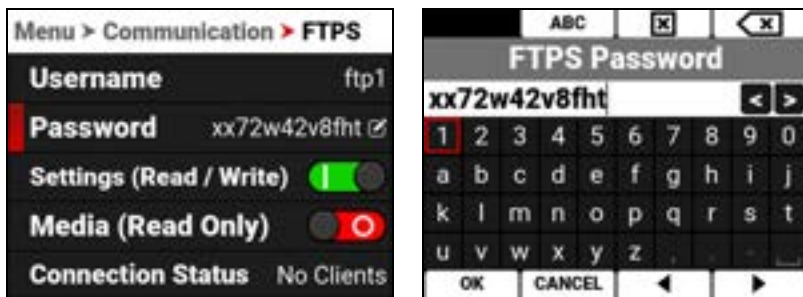

The password must contain a minimum of 8 characters.

## SERIAL

Use Serial to configure the serial connection to the [Extension Port](#).

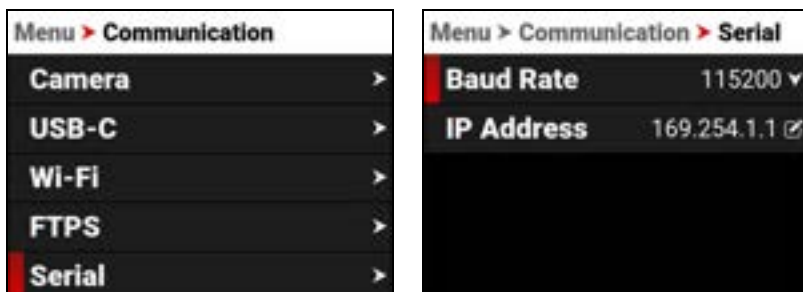

The settings you can configure for the serial connection through the Extension Port include:

ITEM	DETAILS
Baud Rate	Select the serial port baud rate
IP Address	Enter the IP address for the PPP protocol

## BAUD RATE

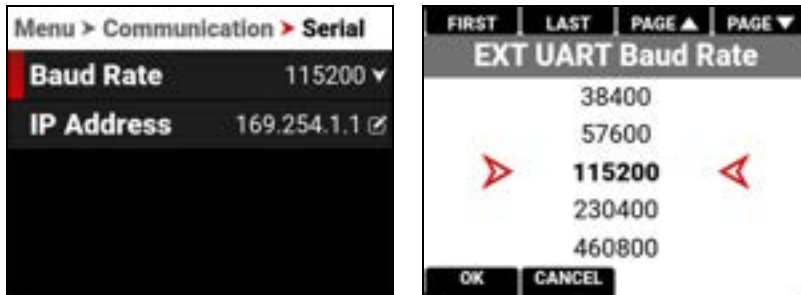

The Baud rate controls how fast data is transmitted over the serial connection. The higher the speed, the more likely that errors can occur. The Baud rates you can choose include:

BAUD RATES			
9600	115200*	576000	1500000
19200	230400	921600	2000000
38400	460800	1000000	2500000
57600	500000	1152000	3000000

\* Default

## IP ADDRESS

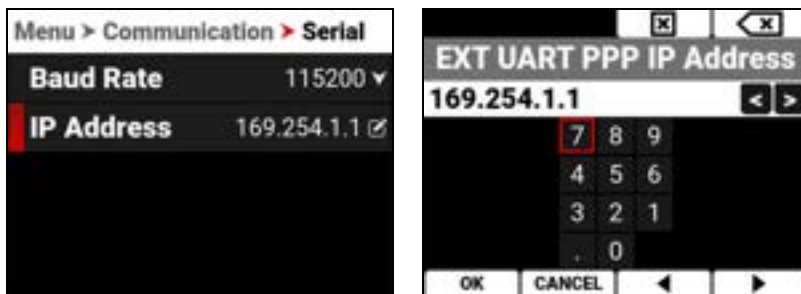

Use the keypad to enter the internet provider's IP address.

## SYSTEM SETTINGS MENU

The System Settings menu contains the camera system configuration settings.

From the camera LCD menu, navigate to System Settings and press SEL:



Use the System Settings menu to configure the camera system settings:

ITEM	DETAILS
Date / Time	Date and time settings
Lens	View lens status information and access the Iris menu
Power	DC and Battery status
Flip / Mirror Sensor Scan	Enable Flip / Mirror Sensor Scan
Side LCD Brightness	Adjust the side LCD brightness
Indicators	Enable or disable the camera's front Tally LED
Status Settings	Shutter mode, Aperture increments, and Focus length units settings
System Status	Information about the camera's type, PIN, FW, and runtime

## DATE / TIME

Use the Date / Time menu to reset the internal clock of the camera. The time and date are timestamped on R3D® files when recording to the media. The camera uses the 24-hour clock convention (military time). For example, enter 2:35 PM as 14:35:00.

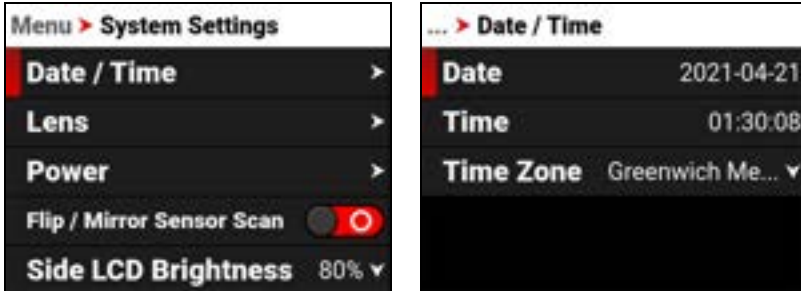

The Date / Time menu items include:

ITEM	DETAILS
Date	Date in YYYY-MM-DD format
Time	24-hour format
Timezone	Global time zones

### DATE

Navigate to Date and press SEL to enter the date using the keypad:

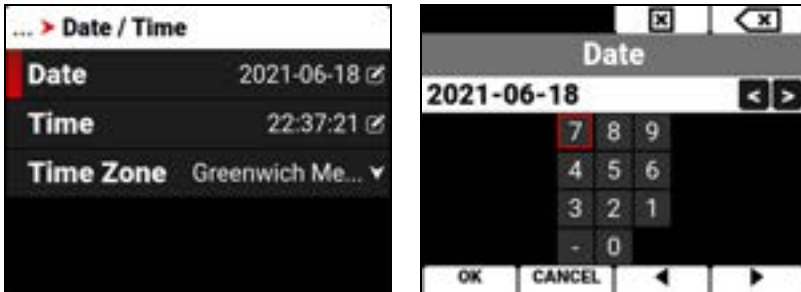

### TIME

Navigate to Time and press SEL to enter the time in 24 hour military format using the keypad:

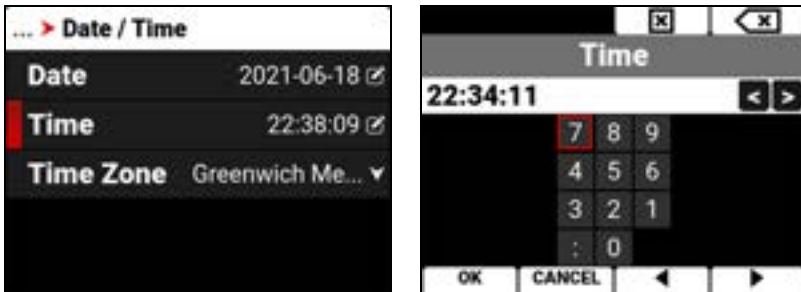

## TIMEZONE

Use Timezone to select the local timezone for where the camera is located.

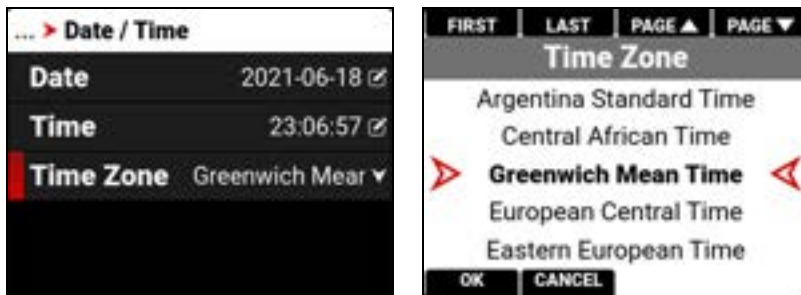

## LENS

Use Lens to view information about the attached lens.

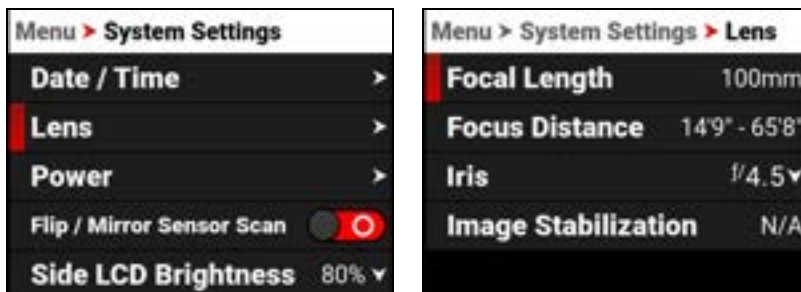

The information you can view from Lens includes:

ITEM	DETAILS
Focal Length	Displays the lens focal length value
Focus Distance	Displays the lens focal distance value
Iris	Lens Iris menu
Image Stabilization	Displays the lens image stabilization status

## IRIS

Use the Iris menu to select the camera lens f-stop. Press the button below Edit to open the keypad and enter the f-stop manually.

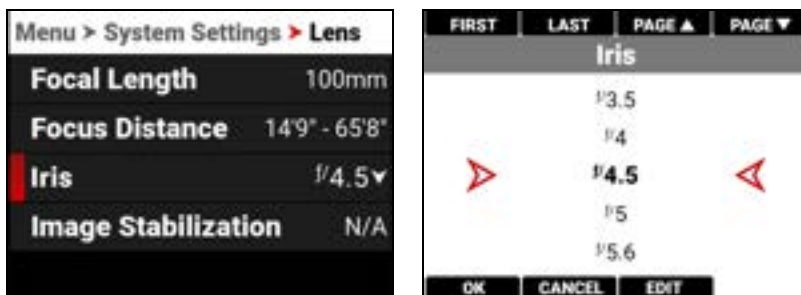

## POWER

Use the Power menu to view the various camera power status indicators:

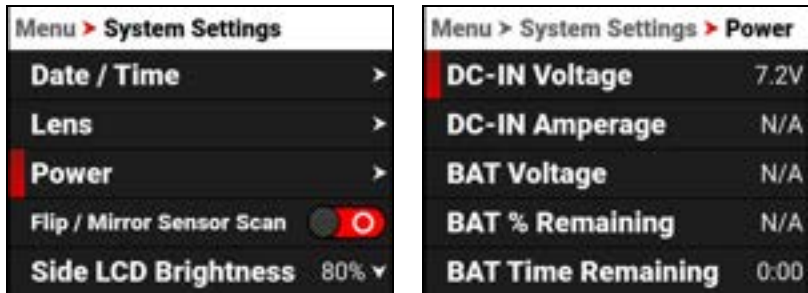

The Power indicators you can view include:

ITEM	DETAILS
DC-IN Voltage	When DC is connected, this displays the DC Voltage
DC-IN Amperage	When DC is connected, this displays the DC Amps
BAT Voltage	When a battery is connected in the left #1 slot, this displays the battery Voltage
BAT % Remaining	When a compatible battery is connected in the left #1 slot, this displays the % of battery charge remaining
BAT Time Remaining	When a battery is connected in the left #1 slot, this displays the camera operating time remaining
BAT Amperage	When a battery is connected in the left #1 slot, this displays the battery Amps
Power Out	Enables or disables the 5 V / 500 mA power to the <a href="#">Extension Port</a>

## INDICATORS

Use the Indicators menu to enable or disable the tally light (refer to the [Camera Body](#) section for more information about the camera LEDs).

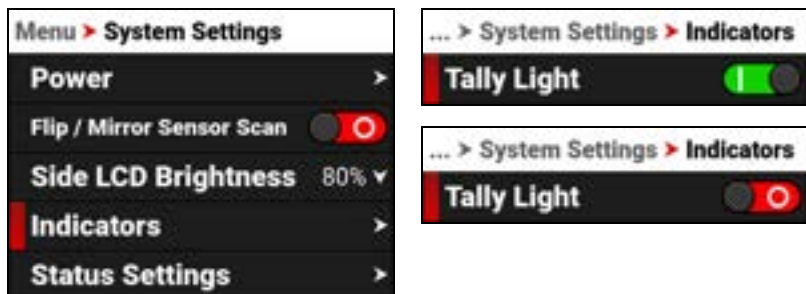

## STATUS SETTINGS

Use the Status Settings menu to select the shutter display mode, aperture increment, and focus distance units displayed in the camera's menus.

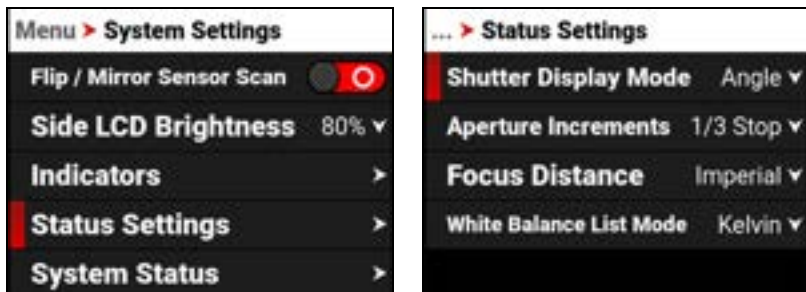

The Status Settings that you can configure include:

ITEM	DETAILS
<a href="#">Shutter Display Mode</a>	Select a time-fraction or an angle for the shutter menu display unit
<a href="#">Aperture Increments</a>	Select 1/4 or 1/3 f-stop increments
<a href="#">Focus Distance</a>	Select the focus distance units (Metric or Imperial)
<a href="#">White Balance List Mode</a>	Select Kelvin or White Balance Presets



## SHUTTER DISPLAY MODE

Use Shutter Display mode to select the way that the camera displays the **Shutter** setting in the menu.

When select Angle, the **Shutter** menu displays the choices in degrees. When you select Time, the Shutter menu displays the choices in fractions of a second.



## APERTURE INCREMENTS

Use Aperture Increments to select one fourth increments or one third increments for the camera f-stop settings. The default is 1/3 Stop.



## FOCUS DISTANCE

Use Focus Distance to select Imperial or Metric units for the **Lens** Focus Distance display. The default is Imperial.

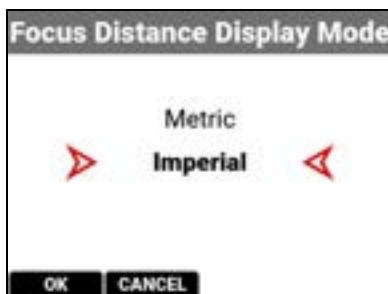

## WHITE BALANCE LIST MODE

Use White Balance List Mode to select Kelvin or Presets for the White Balance Color Temperature menu. The default is Kelvin.

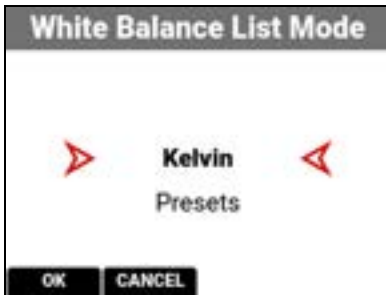

## SYSTEM STATUS

Use the System Status menu to view camera information and to view temperature readings.

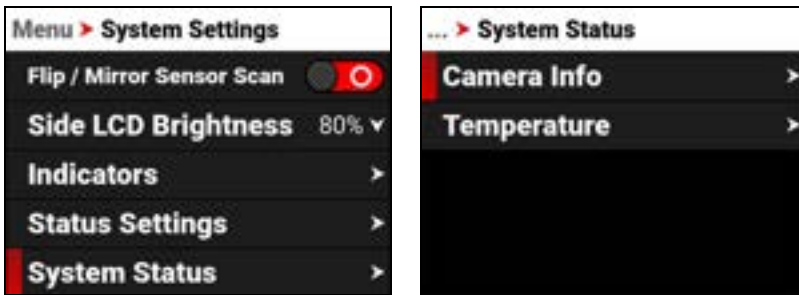

The system status information you can view includes:

ITEM	DETAILS
Camera Info	Camera information
Temperature	Camera temperatures

## CAMERA INFO

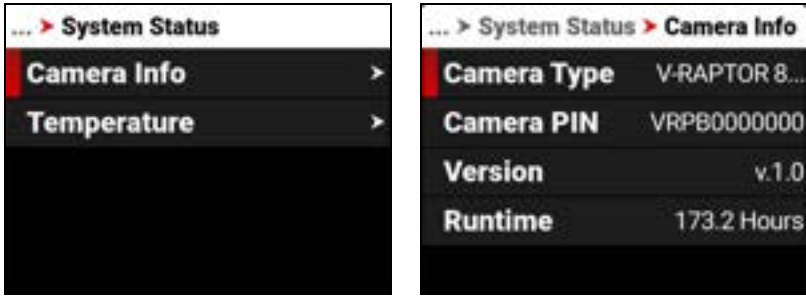

The camera information you can view includes:

ITEM	DETAILS
Camera Type	Displays the camera description
Camera PIN	Displays the camera personal identification number (PIN)
Version	Displays the firmware version number installed on the camera
Runtime	Displays the total number of hours that the camera has run

## TEMPERATURE

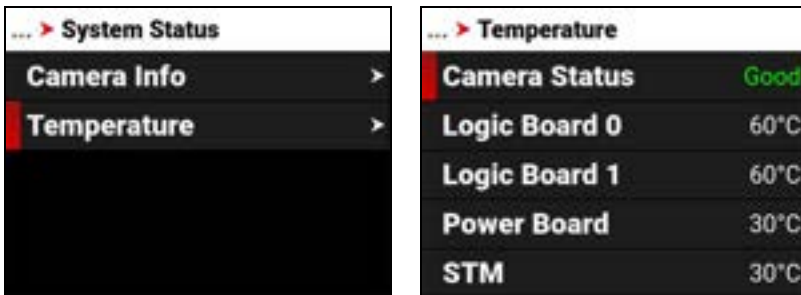

The camera temperatures you can view include:

ITEM	DETAILS
Camera Status	Displays Good (green) or Overheating (yellow)
Logic Board 0	Displays the Celsius temperature of Logic Board 0
Logic Board 1	Displays the Celsius temperature of Logic Board 1
Power Board	Displays the Celsius temperature of the power IC board
STM	Displays the Celsius temperature of the power STM IC
Sensor	Displays the Celsius temperature of the sensor
Calibration Temperature	Temperature at which the sensor was calibrated

## LANGUAGE MENU

The Language menu contains the languages you can select for the user interface (UI).

From the camera LCD menu, navigate to Language and press SEL:

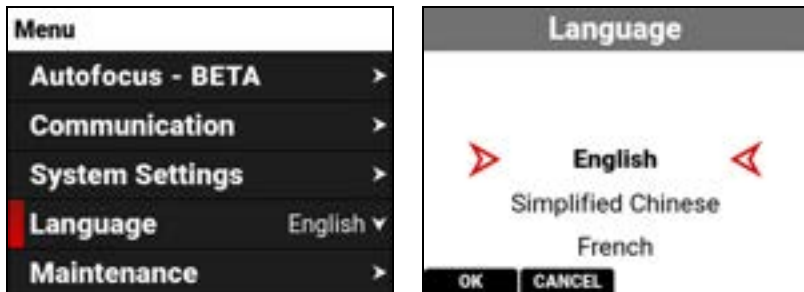

The languages you can select include:

- English
- Simplified Chinese
- French
- German
- Japanese
- Spanish

## MAINTENANCE MENU

The Maintenance menu contains the settings you use to perform various maintenance tasks on your camera.

From the camera LCD menu, navigate to Maintenance and press SEL:

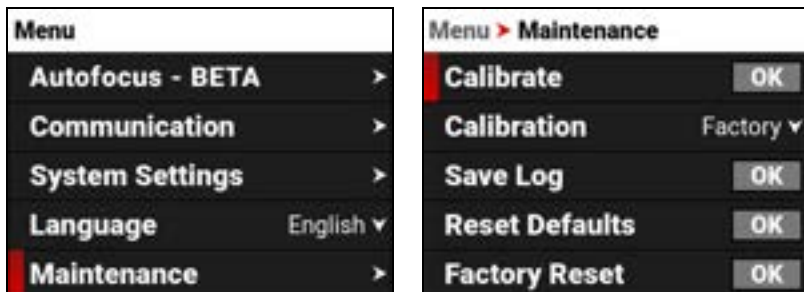

Use the Maintenance menu to perform the following camera maintenance tasks:

ITEM	DETAILS
Calibrate	Performs the selected Calibration
Calibration	List of calibration options
Save Log	Saves the camera log files to the media
Reset Defaults	Resets the camera settings to their default settings
Factory Reset	Restores the camera to the factory settings
Upgrade	Updates the firmware

## CALIBRATE

Use Calibrate to start the camera calibration process and create your User calibration profile.

Only calibrate the camera after it has reached its operational temperature. This occurs usually within ten minutes after you turn on the camera in the filming environment. Do not calibrate immediately after powering on.



**NOTE:** Make sure that the mount cap is installed on the camera before you calibrate the camera.

Press the button below OK to begin calibrating the camera.

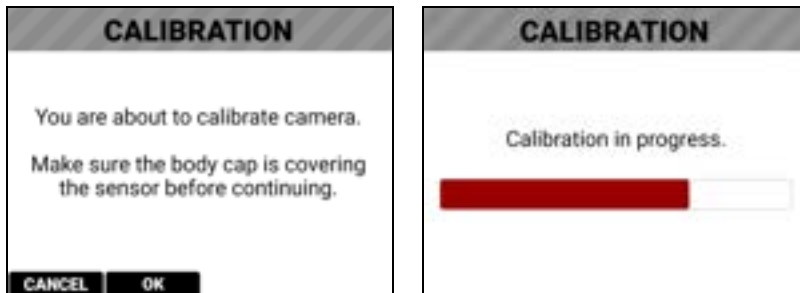

When the camera is finished calibrating, the LCD displays the Calibration status message:

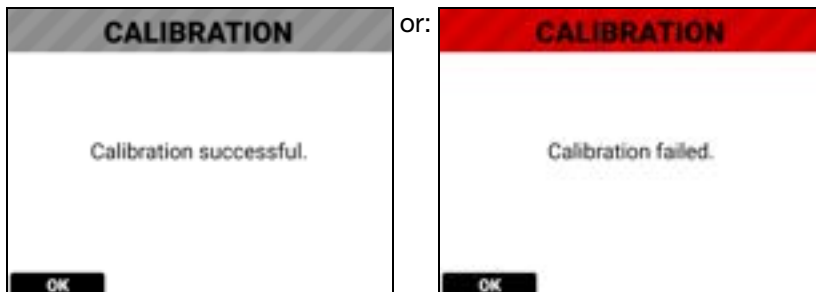

## CALIBRATION

Use Calibration to select the active camera Calibration.

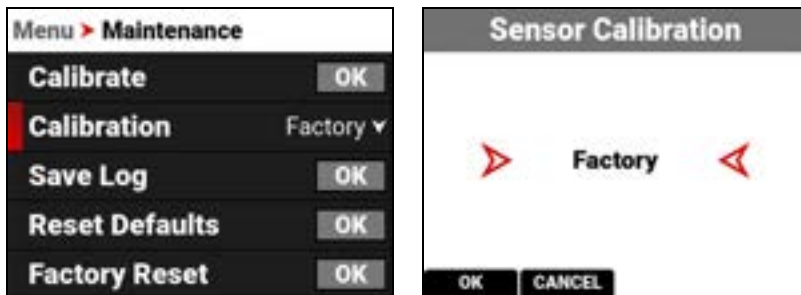

You should always select User calibration. The first time you calibrate the camera, the only choice is Factory. After you perform a calibration, the User calibration profile is added to the list and the camera makes it the default calibration. Every time you calibrate the camera, the User profile is updated. The only time the User profile is removed, is when you perform a Factory Reset.

If User calibration is not available, the camera defaults to Factory calibration. Calibrate the camera to generate a new User calibration profile.

## SAVE LOG

Use Save Log to save the camera log to the media.



When the media is full, or missing, the camera will display an error message. When there is no error, the success message is displayed.

Error:



Success:



## RESET DEFAULTS

Use Reset Defaults to reset the camera to the factory default menu settings.

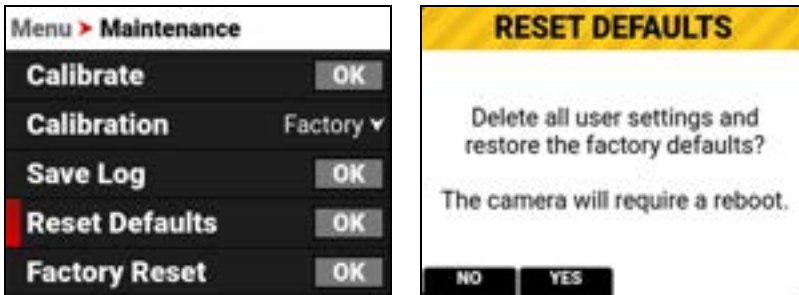

**NOTE:** Resetting the camera will delete all of your menu settings.

**NOTE:** The camera turns off, and then back on to complete the reset process.

Press the button under Yes to reset the camera menus to the defaults settings.

## FACTORY RESET

Use Factory Reset to reset the camera to the factory settings.

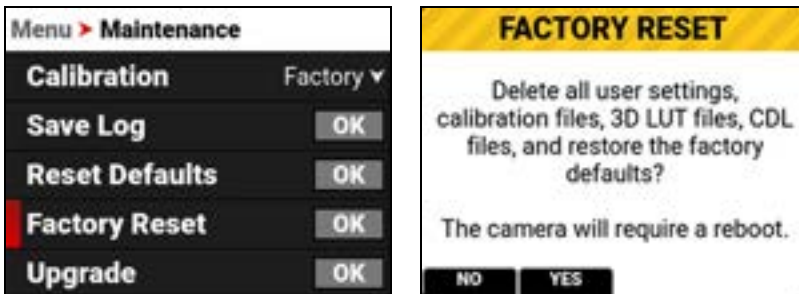

**NOTE:** Resetting the camera will delete all of your settings and remove all imported files. The camera turns off, and then back on to complete the reset process.

Press the button under Yes to reset the camera to the factory settings.

## UPGRADE

Use Upgrade to perform a camera firmware update.

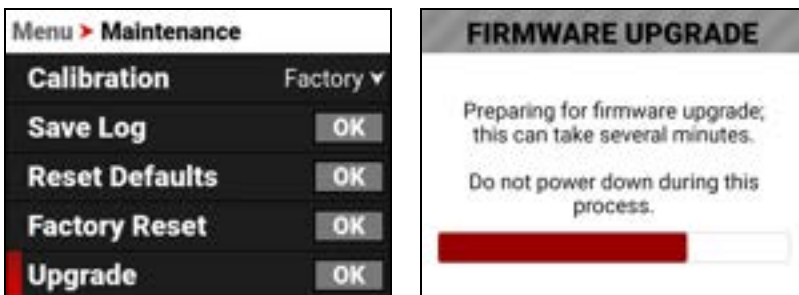

For more information about upgrading the firmware, refer to [Upgrading the Firmware](#).

## 5. HOW TO

This section describes how you can use the camera features.

### WI-FI CONFIGURATION

The camera offers a wireless (802.11g) connection that provides communication support for third-party applications. As with all wireless devices, the communication range varies with the environment and any radio frequency (RF) interference that may be present. You can select a wireless frequency of 2.4 GHz or 5 GHz. For optimal performance, do not obstruct the antenna with any accessory, mounting plate, or mounting rail.

The camera uses **Ad-Hoc** mode to set up the camera as a Wi-Fi hot spot.

The camera uses **Infrastructure** mode to connect to existing Wi-Fi infrastructure.

### CONNECTING WIRELESSLY TO AN EXISTING WI-FI NETWORK

This camera uses the WPA2 Wi-Fi protocol.

1. Navigate to the Wi-Fi menu **MENU > COMMUNICATION > Wi-Fi**.



2. From the Mode option, select Infrastructure.



3. From the Infrastructure menu, select Networks.

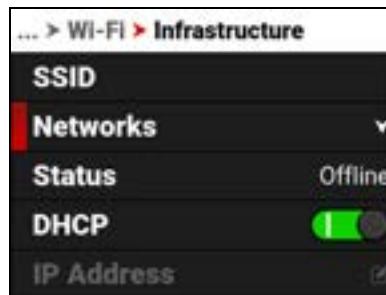
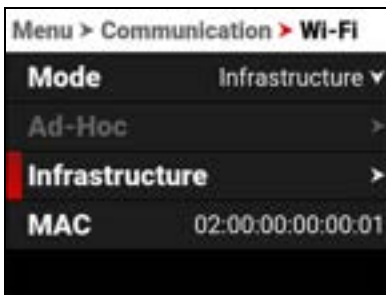



4. Select the network name from the Networks list menu:

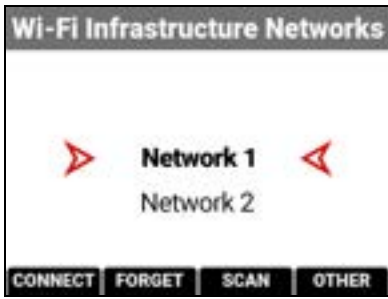

or press the button under SCAN to scan for available networks and update the Networks list:

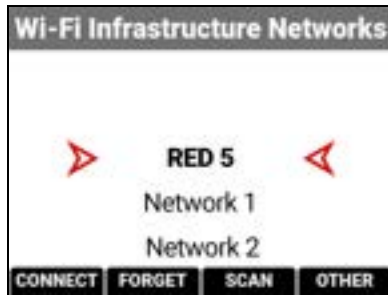
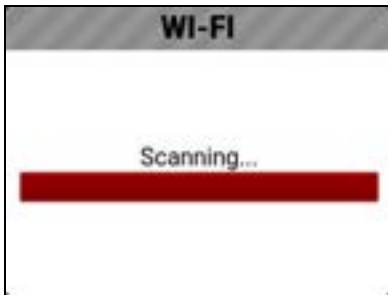

5. Press the button under CONNECT. The CONNECT screen displays:



6. Press SEL. The Passphrase entry screen displays:

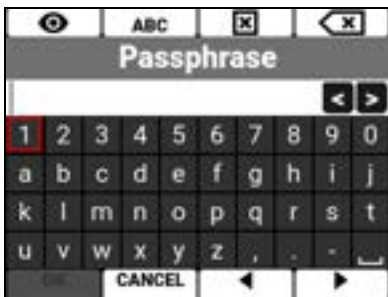

7. Enter the passphrase for the selected network. The passphrase must use a minimum of 8 characters.

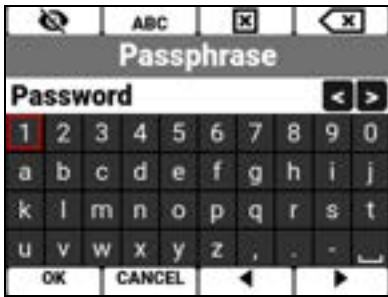

8. Press the button below OK on the completed Passphrase entry screen. The completed CONNECT screen displays.



9. Press the button under CONNECT. The camera connects to the selected network:



## FTPS CONFIGURATION

The File Transfer Protocol Secure (FTPS) offers a fast and secure system for transferring data to and from the camera. FTPS is available when the camera is enabled and connected to a network over Wi-Fi or through the USB-C port to an Ethernet adaptor.

The settings for using FTPS on the camera include:

- **Protocol:** FTP or FTPS
- **Host:** [IP ADDRESS OF THE CAMERA]
- **Port:** 21
- **Encryption:** TLS/SSL Explicit encryption
- **Username:** [USERNAME IN FTPS MENU SETTINGS]
- **Password:** [PASSWORD IN FTPS MENU SETTINGS]
- **Logon Type:** Normal

### NOTE:

- File transfer speeds may vary depending on the strength of the signal (when using Wi-Fi) and the amount of network traffic. For the fastest and most reliable data transfer, we recommend using a hard-wired connection.
- Steps may differ depending on which FTP software you wish to use, consult your software's user guide for additional assistance.
- When setting up FTP, make sure you use FTP or FTPS and not SFTP as these are different protocols.
- For security reasons, the FTPS host name and password are only displayed on the camera FTPS menu.

## CAMERA SET-UP

1. Connect your camera to the network with the desired connection method (Ad-Hoc, Infrastructure or USB-C) and verify the connection. A successful connection is confirmed when the camera displays "Connected" in the Wi-Fi Status:



2. Navigate to Menu > Communication > FTPS. Take note of the username and password. You can also enter a new password.



3. Enable the user permissions by toggling Settings or Media to the on or off position. The media folder will display as an empty folder on the FTP App when Media Access is disabled (off).
4. The camera is now set-up on FTPS.

## SOFTWARE SET-UP (FILEZILLA)

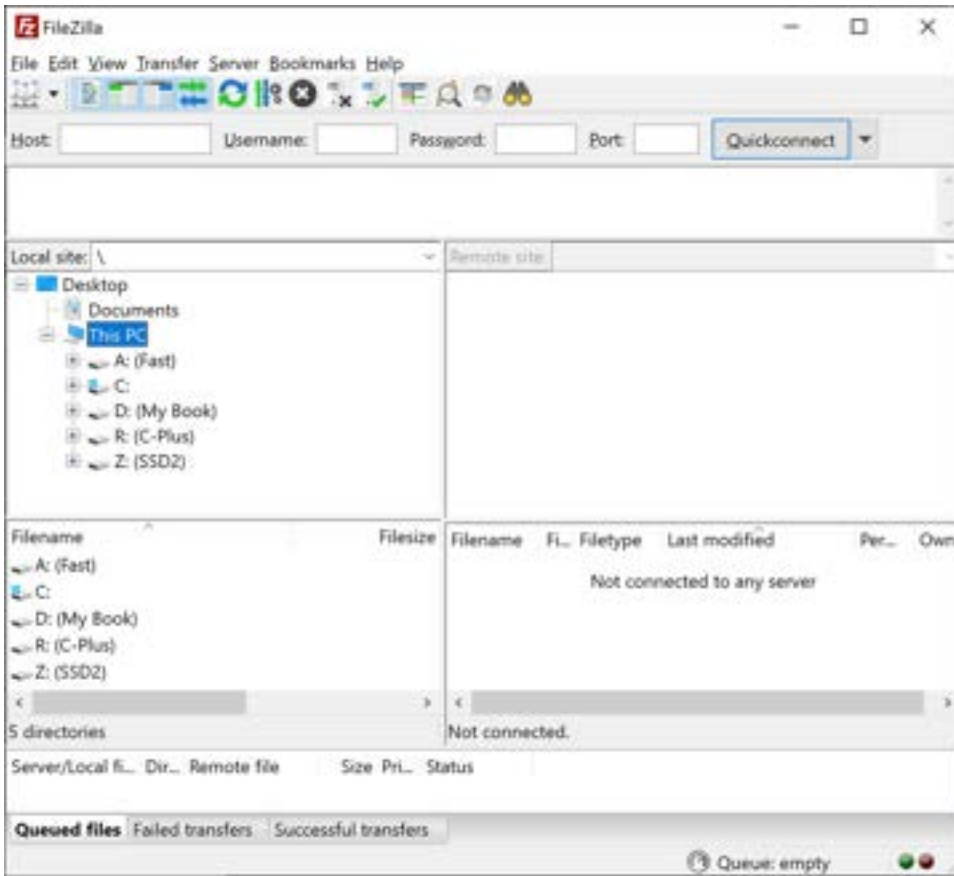

1. In FileZilla, enter the following settings:
  - Host: ftp://*Camera's IP Address* - Example: ftp://192.168.1.93
  - Username: Username displayed in FTPS menu
  - Password: Password displayed in FTPS menu
  - Port: leave blank

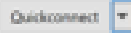
- Click on Quickconnect . Depending on the permissions you will now have access to the desired folders.

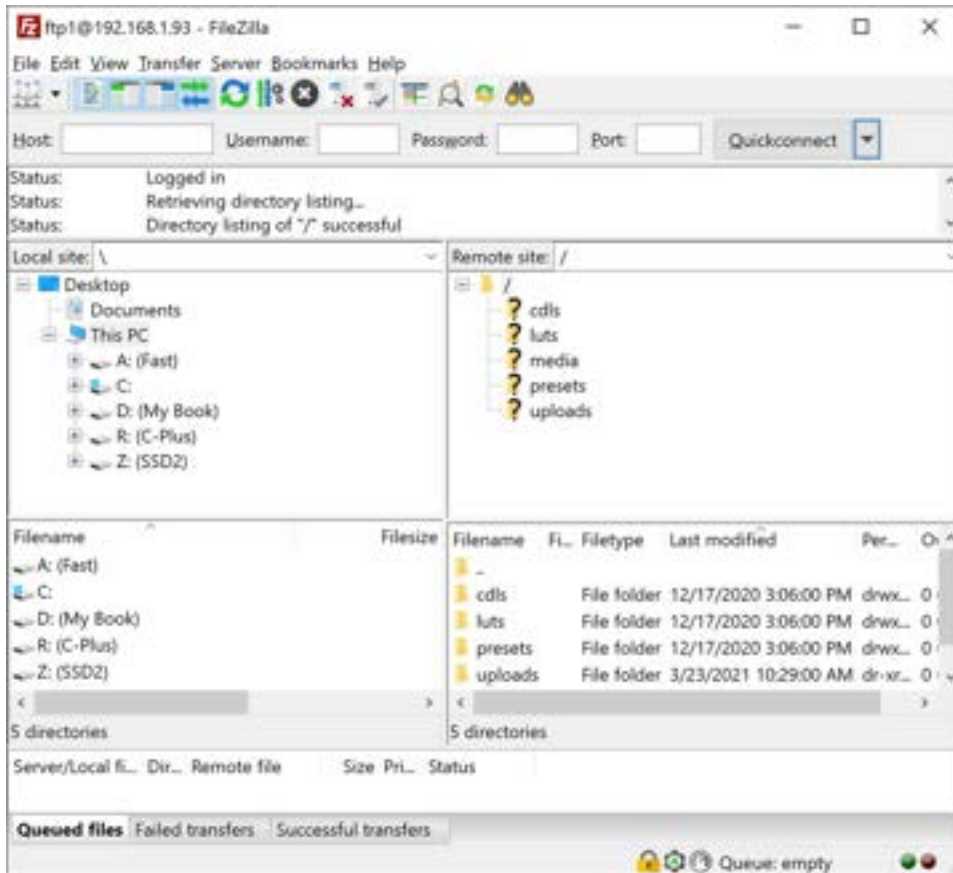

The camera FTPS menu Connection Status displays Connected:

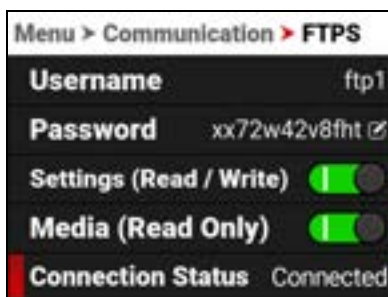

## ADDITIONAL INFORMATION

When uploading files to the camera, make sure that you use the 'upload' folder & then the desired sub-directory of luts, cdls, presets, or upgrade. Media cannot be uploaded to the camera.

The data rate of the FTPS transfer with encryption maxes out at roughly Gigabit Ethernet speeds.

Estimated download time for a full 256 GB is approximately 47 minutes when using a wired connection.

## USB-C CONFIGURATION

The RED V-RAPTOR 8K VV offers a USB-C connection that provides communication support for Android devices, Apple devices, and Ethernet devices.



This section includes instructions for:

- [USB-C Android Configuration](#)
- [USB-C Apple Configuration](#)
- [USB-C Ethernet Configuration](#)

## USB-C ANDROID CONFIGURATION

The RED V-RAPTOR 8K VV offers a USB-C connection that provides communication support for Android devices.

### CONNECTING TO AN ANDROID DEVICE

1. From the Google Play store, download the **RED Control App** to the Android device.



2. Connect the Android device to the camera with a USB-C cable.



3. Navigate to the Communication > USB-C > IP Address.



4. Open the Android device settings by tapping the Settings icon (gear).





5. Select Connections.

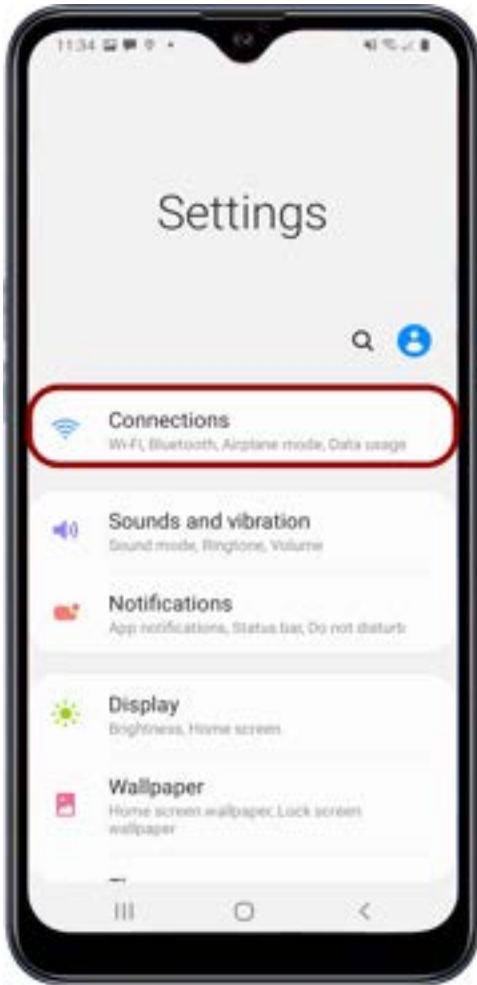

6. Select Mobile Hotspot and Tethering.

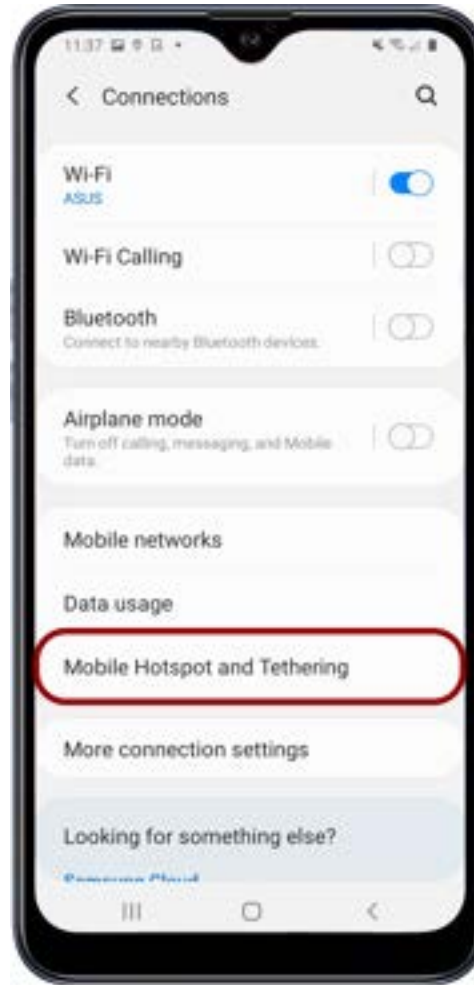

**NOTE:** Mobile Hotspot and Tethering is only available on Android devices with cellular capability.

## 7. Enable USB Tethering.

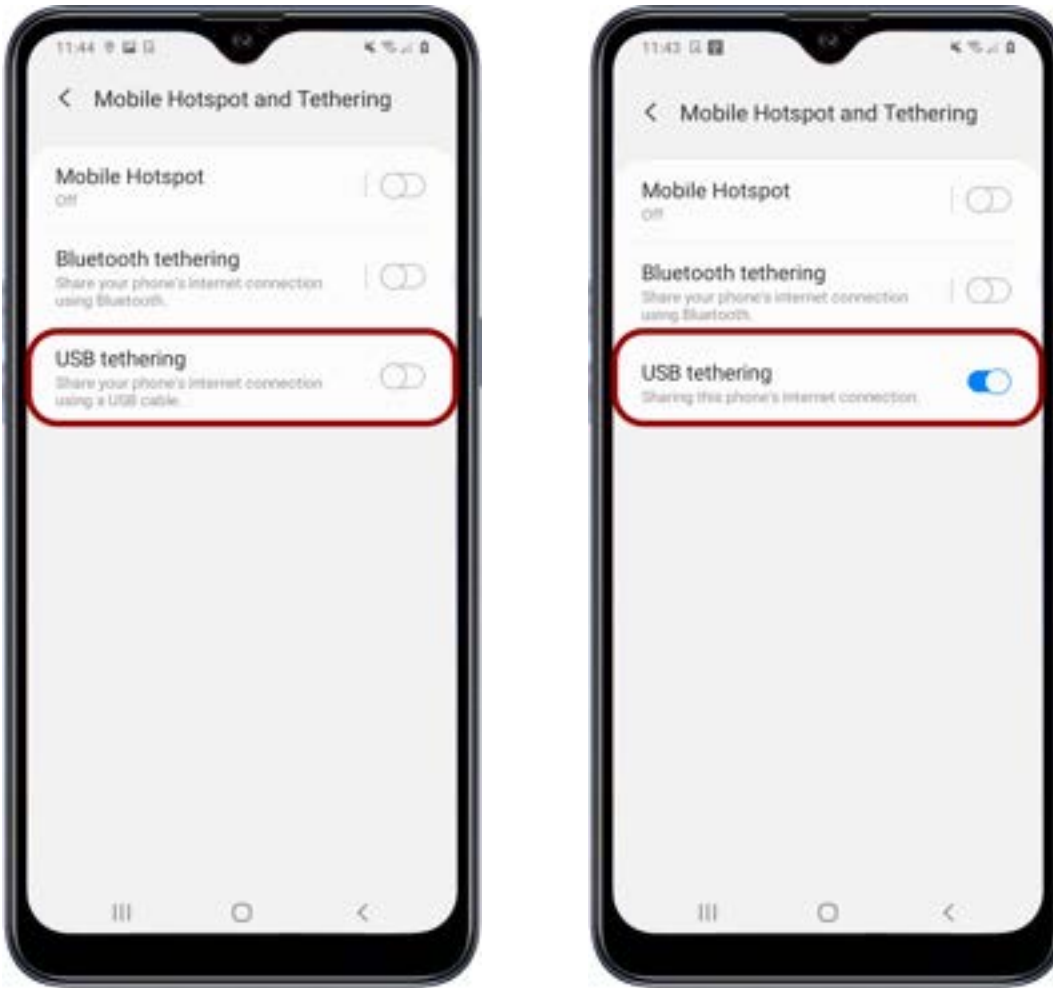

The camera displays the Android device's IP address in the USB-C IP Address screen:

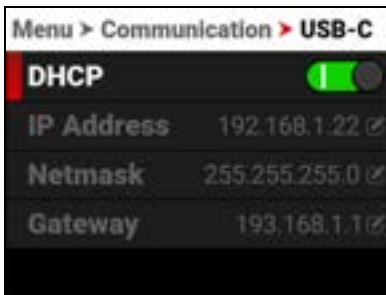

8. From the Android device, tap the RED Control icon to open the RED Control app.



The RED Control app displays the camera connection icon.



9. Tap the icon to open the RED Control app tools for the tethered camera.



From here you can use the **RED Control App** to monitor and control the camera.

## USB-C APPLE CONFIGURATION

The V-RAPTOR 8K VV offers a USB-C connection that provides communication support for Apple devices.

### CONNECTING TO AN APPLE DEVICE

1. From the Apple store, download the **RED Control App** to the Apple device.

**Note:** Scroll to the bottom of the user agreement to accept the agreement.



2. Connect the Apple device to the camera with a USB-C cable. If the "Trust This Computer?" message displays, skip to step 7.

3. Navigate to Communication > USB-C > IP Address.



4. Open the Apple device settings by tapping the Settings icon.



5. Select Personal Hotspot.

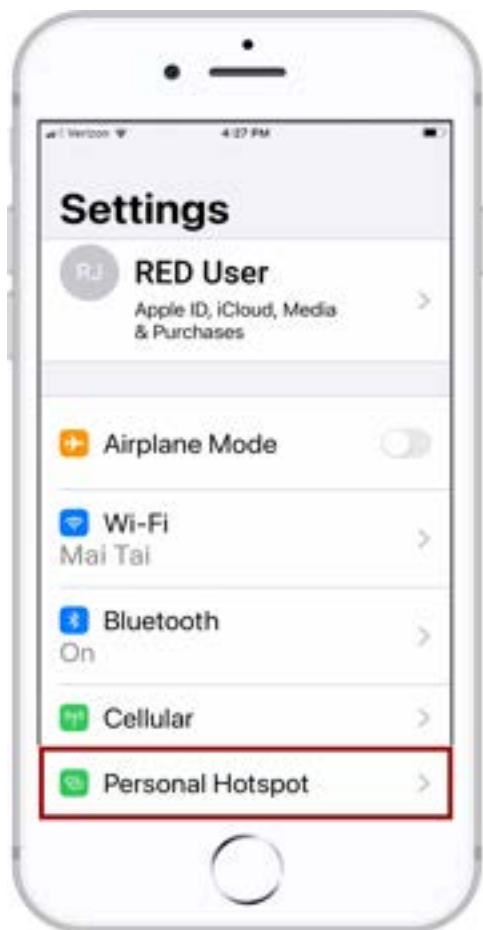

## 6. Allow others to join.

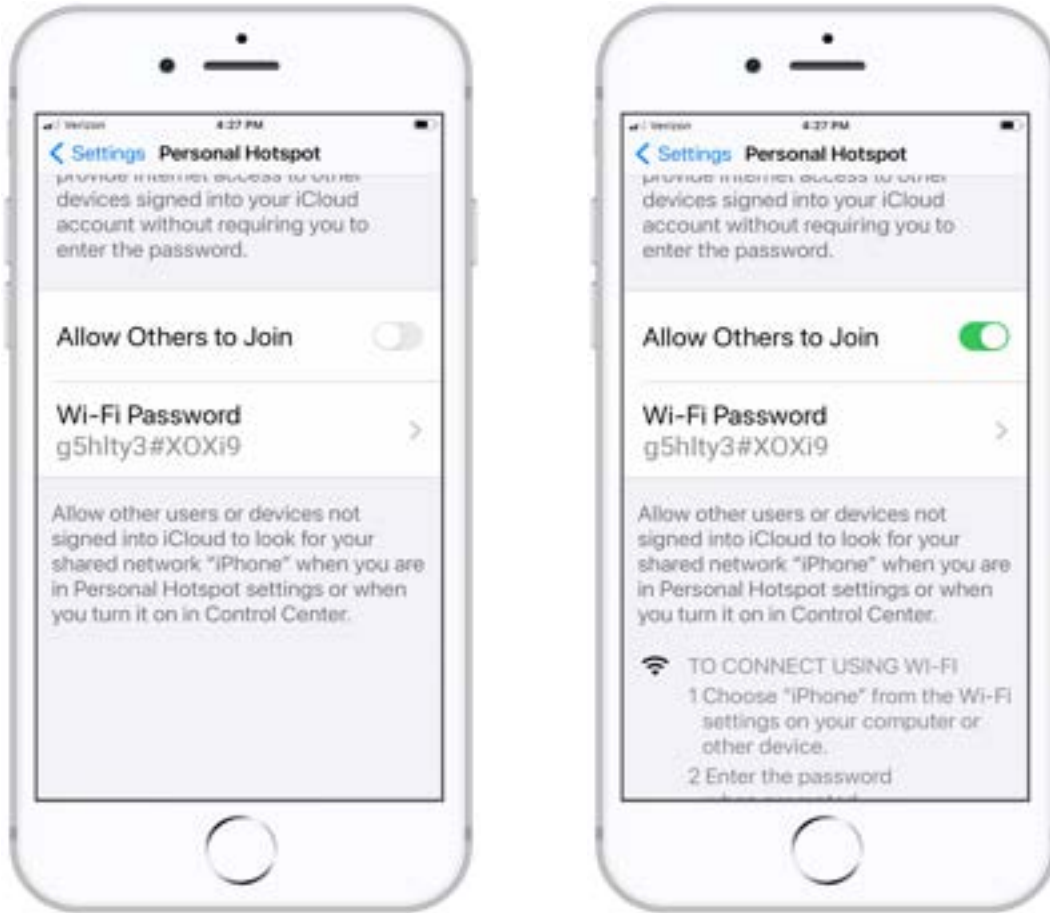



7. The Apple device prompts you to acknowledge that you trust the computer (camera).



The camera displays the Apple device's IP address in the USB-C menu:



8. From the Apple device, tap the RED Control icon to open the RED Control app.



The RED Control app displays the camera connection icon. The word LINK is visible after the IP address.

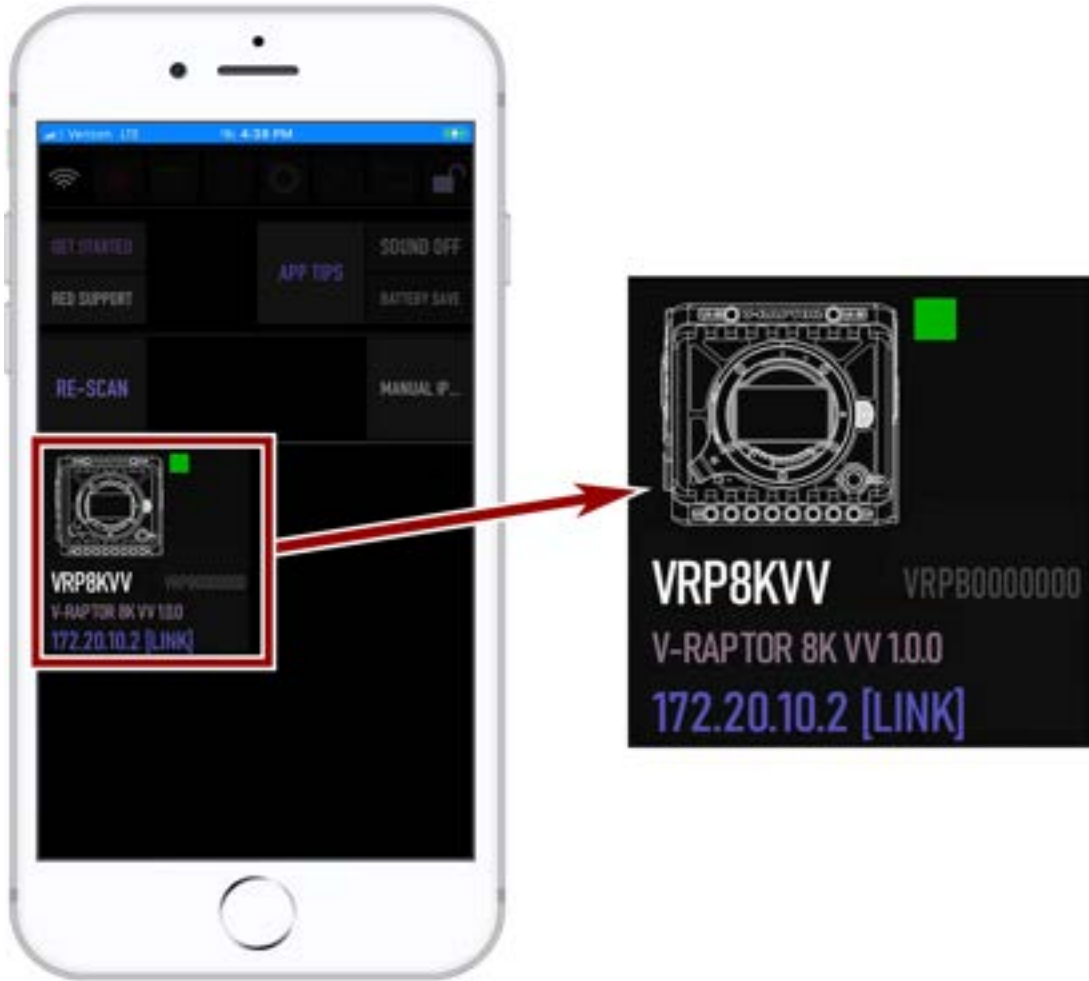

9. Tap the icon to open the RED Control app tools for the connected camera.



From here you can use the RED Control App to monitor and control the camera.

## USB-C ETHERNET CONFIGURATION

The RED V-RAPTOR offers a USB-C connection that provides communication support for Ethernet networks.

### CONNECTING TO AN ETHERNET NETWORK

You must use a USB-C to Ethernet adapter to connect the camera to an Ethernet network.

1. Connect the camera to the Ethernet network using the USB-C to Ethernet adapter.
2. From a Wi-Fi-enabled device, select the Wi-Fi connection to which the camera is connected.



3. Open RED Control on the Wi-Fi-enabled device.



4. Tap RE-SCAN.  
The camera icon displays.



The camera icon displays the camera's Ethernet IP address:



5. Tap the camera icon to open the RED Control app tools for the networked camera.



6. Open a browser from a computer connected to the Ethernet network.
7. In the browser address field, enter the camera IP address displayed on the RED Control camera icon. The RED Control tools are displayed in the browser.

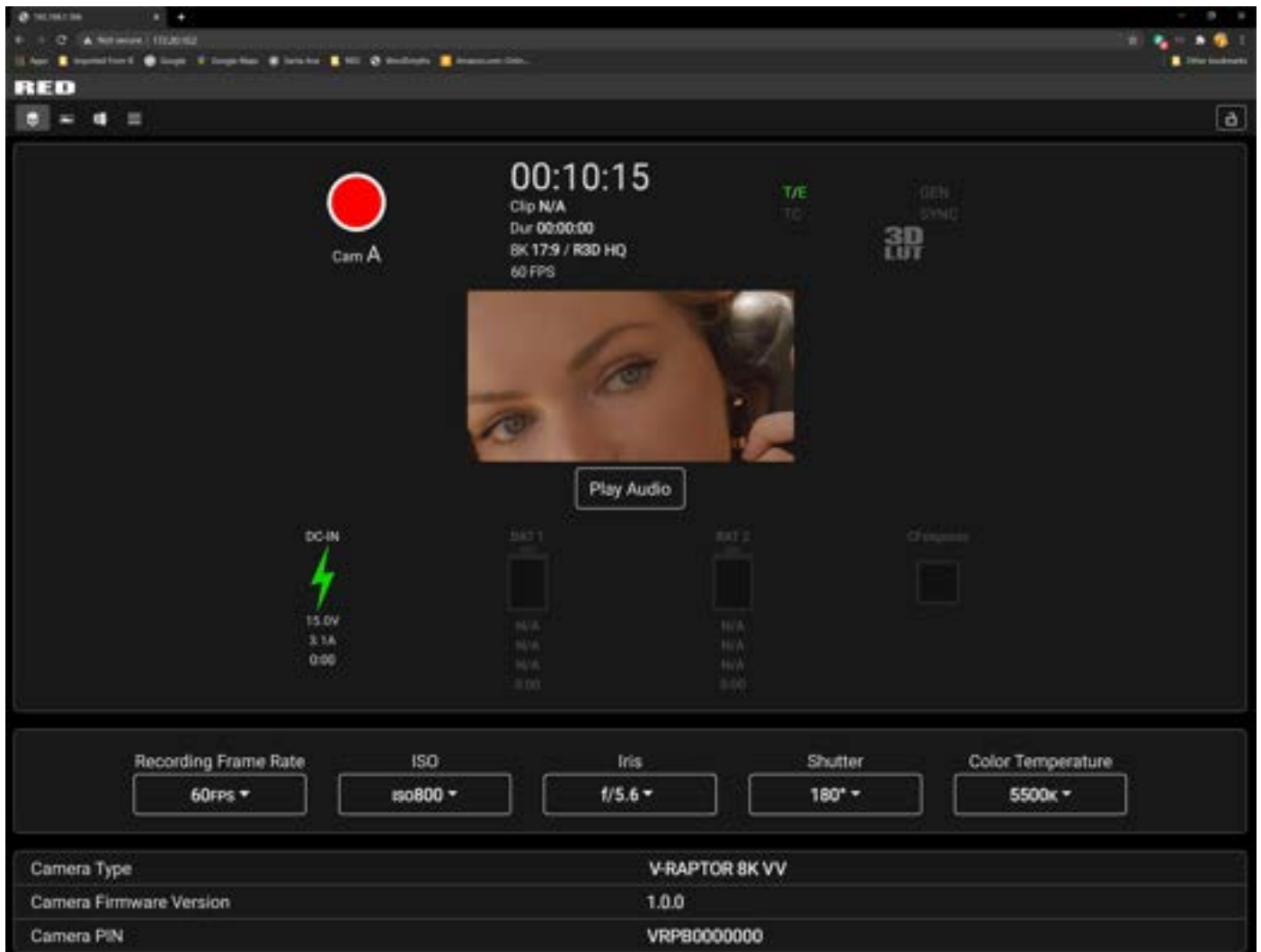

## POWER

### ATTACHING THE BATTERY

Insert a compatible V-Lock battery (refer to [REDVOLT Micro-V Battery](#)) in the battery slot. Slide the battery until it clicks.



The camera can charge the battery while it is attached to the camera, the camera is off, and the DC power adaptor is connected. The DC Power LED blinks amber until communication is established with the battery. The LED is solid amber when communication is established and the battery is charging. The LED is green when communication is not established (incompatible battery) and the battery is not charging.

**NOTE:** Incompatible batteries will not charge on the camera.

### REMOVING THE BATTERY

1. While holding the attached battery, press the **Eject Button**.
2. Lift the battery out.

### POWER COMPONENTS

You can power the V-RAPTOR 8K VV camera with the RED [V-RAPTOR 8K VV Power Adaptor](#), an External DC Power Source, or with the rear-mounted [REDVOLT Micro-V Battery](#).

For information about charging, storing, or maintaining the batteries, refer to the manufacturer's instructions.

## V-RAPTOR 8K VV POWER ADAPTOR

The V-RAPTOR 8K VV 150 Watt AC power adaptor connects to the camera's port to provide DC power for operating the camera and for recharging the attached **REDVOLT Micro-V Battery**.



The camera charges the batteries when the camera is off and the power adaptor is connected.

## AUTO BOOT ON POWER

The camera supports the Auto Boot on Power feature. This means that if all power sources are removed, and the Power Switch is set to ON, then when a power source is attached, the camera turns on.

## POWER CONSUMPTION

The camera draws various levels of power depending on the configuration and operating conditions. The power consumption guidelines are:

- 60 Watts of power in the camera's basic recording configuration at room temperature, 8K, and 24 frames per second
- 75 Watts maximum when the camera is recording in a high ambient temperature, 8K, and 120 frames per second

## POWER PRIORITY

When multiple power sources are connected to the camera, power consumption is prioritized in this sequence:

1. Any power supply connected to the DC IN port.
2. Attached battery.

**WARNING:** Always attach the power or battery before attaching the SDI BNC cable. Always remove the SDI BNC cable before removing the power or batteries.



## TURNING ON THE CAMERA

1. Attach a power source (**REDVOLT Micro-V Battery** or **V-RAPTOR 8K VV Power Adaptor**) to the camera.
2. Slide the **Power Switch** up to the **ON** position.



## TURNING OFF THE CAMERA

**NOTE:** The camera stops recording and turns off automatically when the supply voltage drops to 11.5 V.

**NOTE:** Do not turn off the camera while the camera is recording or formatting media.

Slide the **Power Switch** down to the **OFF** position.



## MEDIA MANAGEMENT

This section explains how to use, record, format, and offload media for the camera.

**WARNING:** Do not attach a label to the CFexpress media card. The heat generated by the media can weaken the label's adhesive, causing the label to detach inside of the camera. Labels can also diminish heat dissipation and cause excessive wear to the internal components. Removing a label from a CFexpress media card can possibly deform the card body.

The camera supports exFAT as the file system for the media card to accommodate larger files and data rates. exFAT is supported both on macOS and MS Windows.

## EJECTING MEDIA

**IMPORTANT:** To ensure data integrity, media must always be ejected prior to removal from the camera. This ensures that power is removed from the media and any open data files are closed. Failure to properly eject media may result in lost data or corrupted files.

To eject media from the camera, use the **LCD** and select **Menu > Media**.



With Eject highlighted, press SEL to eject (unmount) the media:



The Success message displays:



The media is now ejected and all media related items are grayed out in the menu.



**WARNING:** The media can get extremely hot. Use caution when removing media.

Removing a CFexpress media card without ejecting first does not damage the media, however, it does increase the risk of file corruption. It is good practice to eject the media before removing or disconnecting. Ejecting the media provides the following benefits:

- Protects the integrity of your recorded data
- Mounts clips instantly to your workstation in post production

**NOTE:** If you remove media without ejecting first, you receive a warning notification: “Media removed without first ejecting. Data integrity risk.” Always eject media before physically removing the CFexpress media card to protect your media and footage.

## INSERTING MEDIA

The camera contains a covered compartment on the left side where you insert the CFexpress media card.

**WARNING:** Do not attach a label to the CFexpress media card. The heat generated by the media can weaken the label's adhesive, causing the label to detach inside of the camera. Labels can also diminish heat dissipation and cause excessive wear to the internal components. Removing a label from a CFexpress media card can possibly deform the card body.



## INSERTING THE CFEXPRESS MEDIA CARD

1. Press the media door access latch down, and open the media door.



2. Insert the CFexpress media card in the slot with the top of the card facing toward the front of the camera. Insert the card until the lock clicks.
3. Close the media door and make sure that the door latch clicks.
4. If needed, format the CFexpress media card. Refer to [Secure Format](#) for more information.

## REMOVING THE CFEXPRESS MEDIA CARD

**NOTE:** Do not remove the CFexpress card while the camera is recording or formatting media. Refer to [Media Management](#) for more information.

**WARNING:** The media can get extremely hot. Use caution when removing media.

1. If the camera is on, go to **Menu > Media** and select **Eject**.
2. Press the media door access latch down and open the media door.



3. Press the CFexpress media card until the lock release clicks. The card will spring out slightly.



4. Let the CFexpress media card cool before gently pulling the card out of the slot.

**WARNING:** The media can get extremely hot. Use caution when removing media.

5. Close the media door and make sure that the door latch clicks.

## SECURE FORMAT

A secure format is a low level format that rebuilds the CFexpress card file system. A secure format erases all data on the card.

Perform a secure format when the camera is reporting media-related errors.

### PERFORMING A SECURE FORMAT

**CAUTION:** Ensure all data is backed up before formatting a card. **Data erased during formatting cannot be recovered.**

**WARNING:** The media can get extremely hot. Use caution when removing media.

To perform a secure format, follow the instructions below:

1. Go to **Menu > Media > Secure Format:**



2. From the Secure Format menu, select the desired **Camera ID**, **Camera Position**, **Reel Number** and **Edgecode**. Navigate down to the **Format** button and press SEL to start the Secure Format process:



The confirmation message displays:



3. Press the button below YES to begin formatting.

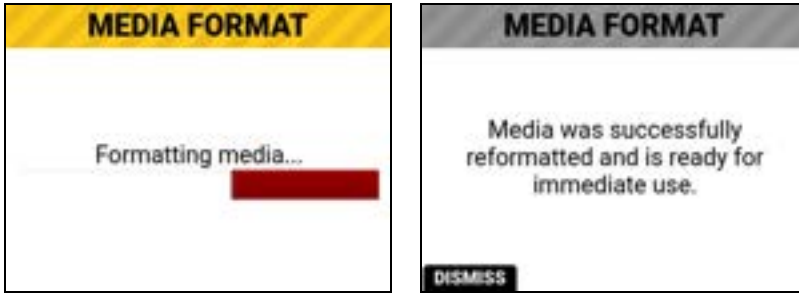

## FORMATTING MEDIA ON A COMPUTER

RED recommends that you only use a computer to format your CFexpress media card when you cannot mount the media to the camera. Refer to the [Troubleshooting](#) section for more information.

## MEDIA INFORMATION

Use the [Media Info](#) menu to display the CFexpress media card information.

Media information includes the following:

ITEM	DETAILS
Status	Displays the CFexpress media card status
Model Number	Displays the CFexpress media card model number
Serial Number	Displays the CFexpress media card serial number
Firmware Version	Displays the CFexpress media card firmware version
Percentage Remaining	Displays the CFexpress media card's remaining storage*
Time Remaining	Displays the recording time remaining on the CFexpress media card*

\* with the current project settings

## FILE SYSTEM

The V-RAPTOR 8K VV camera formats the CFexpress media card using exFAT. Both Mac® and Windows®-based computers support CFexpress media cards with this format. Refer to the documentation for your operating system to determine whether there are any limitations to its file format support.

## CLIP FOLDER NAMING CONVENTION

When you record a clip, the camera creates a unique name for the clip folder that uses the format described in the table below:

ITEM	DETAILS	EXAMPLE
Camera ID	The letter assigned to the camera (refer to <b>Camera ID</b> )	A
Reel ID	The reel number assigned to the media (refer to <b>Reel Number</b> )	004
Clip Number	The camera position letter followed by three digits starting with 001	C001
Month	Month that the clip is recorded (refer to <b>Date / Time</b> )	12
Day	Day that the clip is recorded (refer to <b>Date / Time</b> )	04
Two Characters	Two random alphanumeric characters generated by the camera to prevent any possibility of duplicates	6M
.RDC	Clip folder extension	.RDC

For example, a sequence of clip folders within a media folder on camera "A" position "C" may look like this:

- A001\_C001\_12046M.RDC
- A001\_C002\_1204CE.RDC
- A001\_C003\_1204R5.RDC

## CLIP METADATA

The following metadata is recorded for each frame of each clip:

- Audio Data
- Clip
- Configuration, Camera Name, Network, Model, Model ID, Serial Number
- Copyright
- Date and GMT
- Filename
- Firmware Version
- Frame Guides
- Jamsync Setting
- Lens and Shutter Speed/Angle Parameters
- Lens Name, Brand, ID, Near Focus, Far Focus
- Location
- LTC User Bits (3 32-bit word reg-dump from ISP)
- Media Serial Number
- Production Name
- REDCODE®
- Reel
- Scene
- Stereo Setup
- Take
- Timecode
- Unit



## MEDIA BEST PRACTICES

This section describes best practices to ensure that your CFexpress cards continue to provide reliable storage and fast data rates. Following these best practices may prevent your CFexpress card from becoming fragmented, which can lead to data integrity errors.

- The only files that should be saved from your computer to your CFexpress card are Preset files, Firmware Upgrade files, and LUTs. DO NOT save other files, folders, or applications to your media.
- DO NOT back up your hard drive to the CFexpress card. If using a Mac, the system may ask if you want to back up your files to the CFexpress card using Time Machine; DO NOT use the CFexpress card as a backup disk.
- DO NOT delete clips off of your CFexpress card using a computer. Delete clips only by formatting your CFexpress card in-camera. For more information about formatting your CFexpress card, refer to [Secure Format](#).
- DO NOT format your CFexpress card using a computer, unless the CFexpress card cannot mount to the camera. For more information, refer to [Secure Format](#).
- When ejecting the CFexpress card from a computer, ensure that the icon has completely disappeared from the Finder window (Mac) or from Windows Explorer (Windows) before removing the CFexpress card. Sometimes, the pop-up saying that the CFexpress card has ejected displays too early.
- When the reader has a write-protect switch (such as the [RED CFexpress Type B Media](#)), it is recommended that you set the card reader to write-protect when uploading clips to prevent connected devices from adding any unwanted data to your CFexpress Type B card.

## INDEXING ON A MAC

**NOTE:** You can use the RED CFexpress Type B card reader with Write-Protect to prevent the Mac OS from indexing your CFexpress Type B card (refer to RED CFexpress Type B Reader).

Most newer versions of the Mac OS automatically index all external drives when you connect them. This includes when you connect CFexpress cards.

Indexing makes the connection process take longer. While the CFexpress card connects to the Mac, DO NOT remove the card. Indexing writes hidden files to the CFexpress card. When you insert an indexed CFexpress card in the camera, it can take the camera a while to recognize the hidden files and connect to the CFexpress card. While waiting for the CFexpress card to connect, DO NOT remove the CFexpress card or turn off the camera. After the camera successfully connects to the CFexpress card, perform a secure format to remove the hidden files. For more information, refer to [Secure Format](#).

## RED MONITOR INTERFACE CABLE

The DSMC3 RED® Touch 7.0" LCD monitor includes a custom RED Monitor Interface (RMI) cable that provides communication between the RMI and the monitor.

Where this cable attaches to the RMI and the monitor, there are special locking features that keep the cable from accidentally detaching.

To unlock the cable locks, rotate the RMI cable lock and slide the monitor cable lock as shown in the image:



**NOTE:** The USB-C-style DSMC3 RMI cable is a custom-pinned cable, which is not compatible with standard USB-C cable ports.

## MONITORING

The camera provides several methods for monitoring the image. These monitoring methods include:

- DSMC3 RED® Touch 7.0" LCD
- SDI output to a monitor
- RED Control over Wi-Fi to iOS or Android devices
- RED Control over USB-C to iOS or Android devices
- USB-C to Ethernet adapter to a computer
- Live Stream

## DSMC3 RED® TOUCH 7.0" LCD

The optional DSMC3 RED Touch 7.0" LCD provides a 1920 x 1200 resolution live image from the camera sensor. By using the Monitoring menu you can use display guides, exposure tools, focus tools, and a magnified image on this monitor (refer to [Top LCD](#)).

## SDI OUTPUT TO A MONITOR

SDI ports 1 and 2 provide a 12G SDI signal to allow viewing of the camera image on a 4K SDI monitor.

Use the SDI 1 and 2 menus to select the settings for SDI output, Tools, and Guides (refer to [SDI 1 / 2](#)).

**WARNING:** Under certain circumstances, it is possible for an SDI connector to incur damage when connected to an accessory and powered without using shielded cables. RED recommends only using high quality, shielded BNC cables that are rated for 12G-SDI signals and only using shielded power cables for powering SDI accessories.

Make sure power is connected to the SDI accessory at all times before you connect the BNC to the camera. Ungrounded power from SDI accessories can damage the camera's SDI port. To avoid this possible damage, attach the power source to the accessory before attaching it to the BNC cable. When using RED Approved Third Party battery plates, unplug the BNC cable prior to hot swapping.

When possible, avoid using P-Tap (also known as D-Tap) cables to power accessories. To avoid damage when using P-Tap/D-Tap, it's imperative that the connect/disconnect sequence (below) is followed precisely.

## **BNC ATTACHMENT INSTRUCTIONS**

When attaching SDI accessories:

1. Connect a power source to the SDI accessory; power on the SDI accessory.
2. Ensure a power source is connected to the camera. This ensures both are grounded prior to connecting the BNC. The camera's power state does not have an impact on SDI attachment sequence.
3. Connect the BNC cable to the accessory, then to the camera.

When detaching an accessory mounted to an SDI output, ensure that you remove the BNC connection to the camera before removing power to the SDI device:

1. Shutdown the SDI accessory.
2. Disconnect the BNC cable from the camera.
3. Disconnect the power source from the SDI accessory.

When you need to swap out a battery on an accessory mounted to the camera's SDI port, you must:

1. Shutdown the SDI accessory.
2. Disconnect the BNC cable from the camera.
3. Replace the battery on the SDI accessory.
4. Connect the BNC cable to the camera.
5. Power on the SDI accessory.

For more information, refer to [Preventing Damage to SDI Outputs](#).



Figure: SDI monitor with SDI Advanced Overlay Mode enabled

## SDI port specifications:

- Integrated 12G-SDI with 6G-SDI, 3G-SDI, and 1.5G-SDI modes
- 12G-SDI: Up to 4096 × 2160 4:2:2 for 60p
- 6G-SDI: Up to 4096 × 2160 4:2:2 for 30p
- 3G-SDI: Up to 2048 × 1080 4:2:2 for 60p
- 1.5G-SDI: Up to 2048 × 1080 4:2:2 for 30p and 24p
- SMPTE Timecode
- HANC metadata
- Up to four (4) channels of 24-bit 48 kHz audio (refer to [Audio Source](#))

You can enable or disable the image magnification, the focus and exposure tools, and the guides displayed on images sent to the SDI monitor by using the SDI 1 and 2 menus (refer to [SDI 1 / 2](#)).

From the side LCD, navigate to the SDI tools (refer to [SDI Page](#)).



You can enable or disable the following monitoring tools on SDI, (refer to [SDI 1 / 2](#)):

- Magnify
- SDI tools
- SDI guides

You can also select the Image / LUT look defined in the Image / LUT menu, or you can select the RWG (REDWideGamutRGB) / Log3G10 Image Processing Pipeline (IPP2) look.

## RED CONTROL

RED Control allows you to use Wi-Fi to connect to the camera and send monitor images to iOS and Android devices.

**NOTE:** You must enable live streaming under **MENU > MONITORING > LIVE STREAM** to enable the image feed.

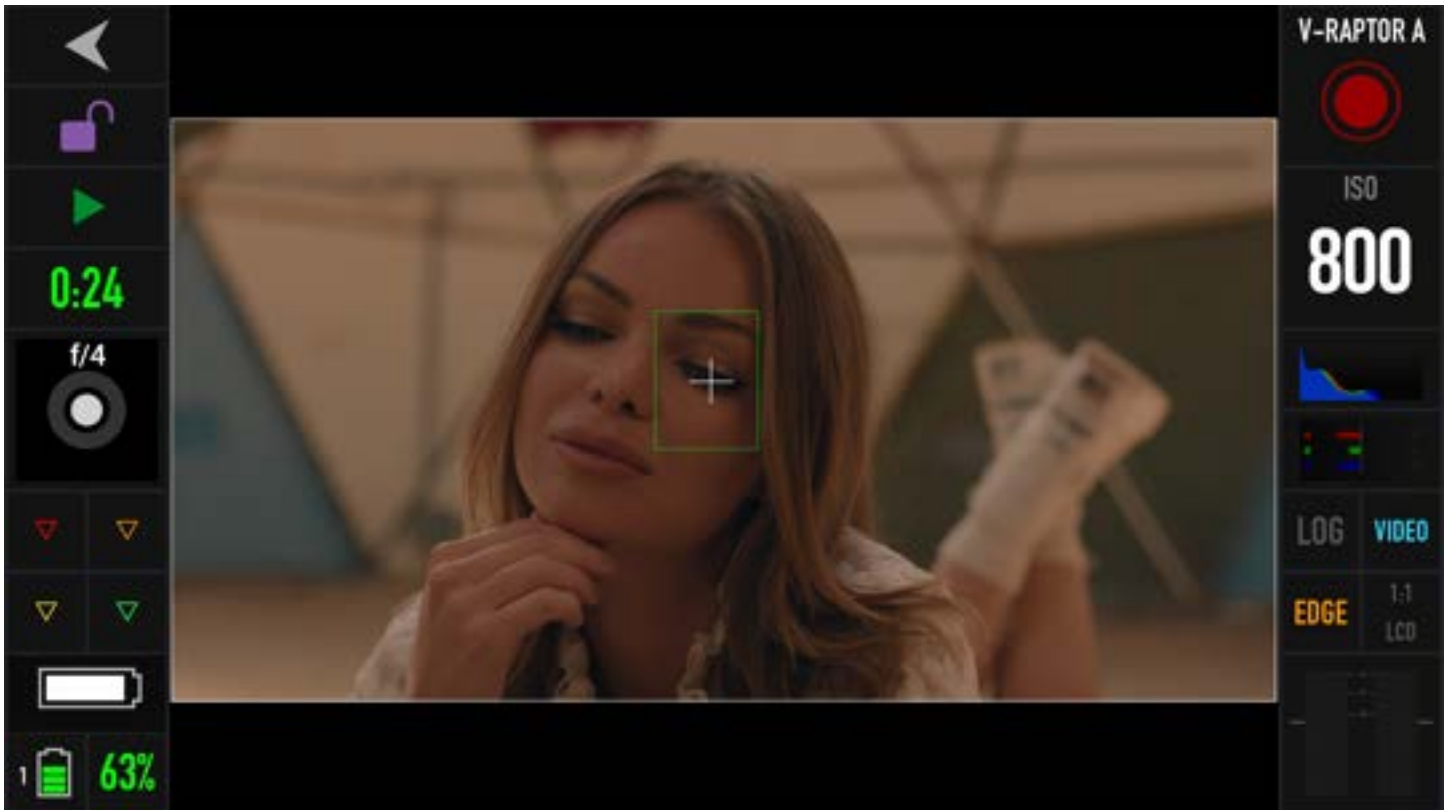

Figure: RED Control phone monitor over Wi-Fi

## USB-C

Use a USB-C cable to connect to the camera and send monitor images in real-time to USB-C devices.

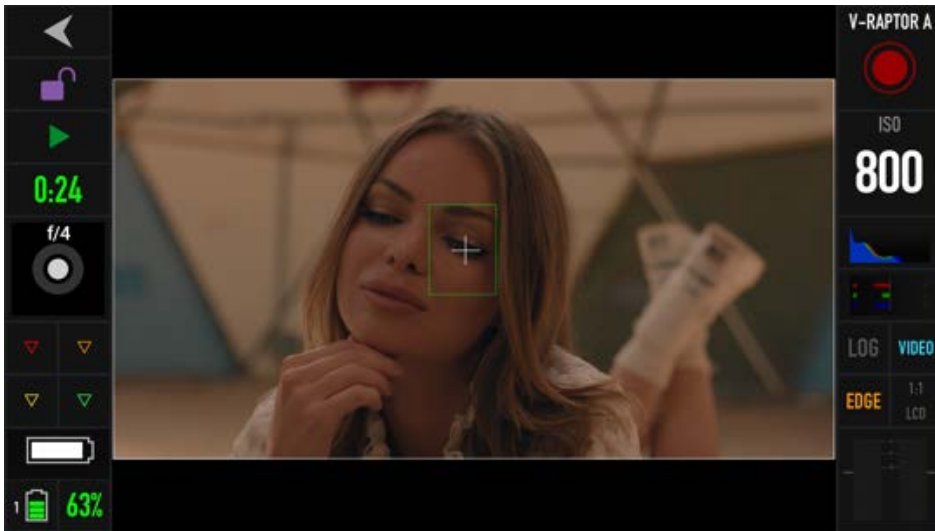

Figure: USB-C connected to an Android phone with RED Control

With the use of an Ethernet to USB-C adapter, you can also connect Ethernet devices.

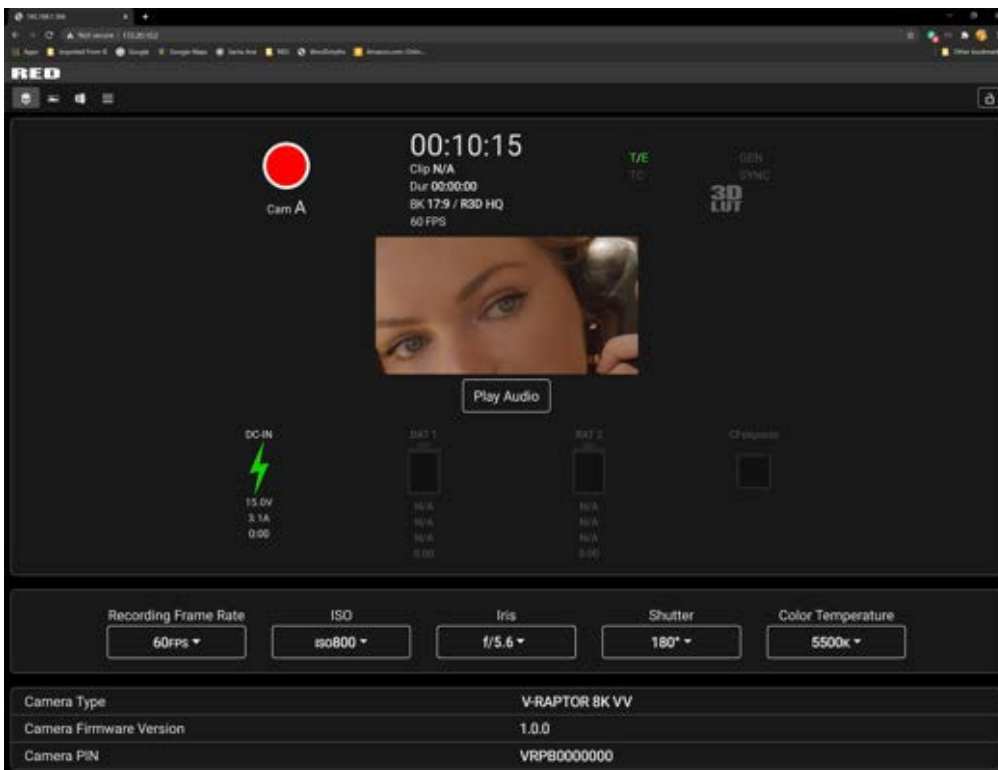

Figure: USB-C connected to an Ethernet web browser

You can add :9090 to the end of the URL in your browser to bring up an image-only feed for remote viewing.

**NOTE:** You must enable live streaming under **MENU > MONITORING > LIVE STREAM** to enable the image feed.

## EXPOSURE

The camera offers multiple tools to determine the current image exposure levels, and it provides the tools to adjust the exposure to the desired levels.

When using the R3D file format, you can correct color temperature and ISO settings at any time. The aperture and exposure time however, are two of the parameters that you cannot corrected later in R3D files.

While the correct exposure is always an artistic decision, there are best practices for capturing the most dynamic range while also allowing post production to preserve the intended image information.

The goal is to reduce clipping in the bright and dark parts of the image as much as possible. Otherwise the sensor information is lost in the overexposed and underexposed areas.

The primary tool for determining the exposure levels is the histogram. It shows the exact luminance levels of the red, green, and blue pixels after you apply the ISO and White Balance settings. Monitors have their own color gamuts and brightness levels which makes the monitor less than optimal for determining the camera's exposure levels.

This camera includes a histogram, and a simple RGB raw pixel exposure meter, which allows you to determine proper exposure regardless of the set ISO or camera look (for more information refer to [Histogram Page](#)).

The histogram provides information about how the brightness is distributed in the image. This allows you to see how close a scene is to clipping in the light and dark areas, which makes it easy to choose aperture, exposure, and ND filter solutions accordingly.

## FALSE COLOR EXPOSURE TOOLS

While the histogram provides information about the brightness distribution and clipping of the image, it does not show you the areas in the image that are near, or that have reached, clipping. For this, the camera provides image overlays that provide false colors to indicate precise exposure levels.

## FALSE COLOR EXPOSURE MODE

The False Color Exposure mode overlay provides information where the image is close to clipping or already clipping in the highlights (red) and low-lights (green) (refer to [False Color Exposure Mode](#)).

Example of monitored image in Exposure Mode:





## FALSE COLOR VIDEO MODE

The False Color Video mode provides more gradual information about the brightness in different parts of the image. This is helpful when you want to expose skin color at the right level, while ignoring the fact that backgrounds might be overexposed or underexposed (refer to [False Color Video Mode](#)).

Example of monitored image in Video Mode:



## FOCUS

Focus, like [Exposure](#) and [Recording Frame Rate](#) is a property that cannot be fixed easily in post-production. To make sure the camera is focused correctly when you begin recording, it is important to employ focus tools that do not rely on the visibility on the monitor.

The camera interface includes the focus tools you can use to reach the desired image focus (refer to [Peaking](#)).

## FOCUS PEAKING MODE

The Focus Peaking mode applies a sharpening filter to the image that emphasizes edges of the subject in focus.

Example of monitored image in Focus Peaking mode:



## EDGE PEAKING MODE

The Edge Peaking mode hides the image and only show the edges. This provides the best visual representation of the subject that is currently in focus.

Example of monitored image in Edge Peaking mode:





## PEAKING PEAKING MODE

The Peaking Peaking mode emphasizes the edges, and it also highlights them by using a selectable color.

Example of monitored image in Peaking Peaking mode:



## TIMECODE

Timecode provides a mechanism to reference frame timing from the camera's recorded clips to other devices like cameras and audio recorders. Some devices can also gather other data like lens metadata or camera orientation that is referenced by Timecode to merge the data back together in post-processing.

V-RAPTOR 8K VV provides two separate Timecode concepts: Time of Day (TOD) and Edgecode. Both TOD and Edgecode are stored in the R3D file. The user can select which Timecode displays on the **LCD** by setting the preference in **Timecode Display Mode**.

## TIME OF DAY

TOD Timecode reflects the time and date the camera recorded each frame. V-RAPTOR 8K VV synchronizes the TOD Timecode to an external Timecode generator (when one is connected to the **Extension Port**) or synchronizes to the internal real-time clock of the camera.

## SETTING UP TOD TIMECODE

To set up TOD Timecode on the camera, perform the following:

1. Open the Audio / Timecode menu: **Menu > Audio / TC:**

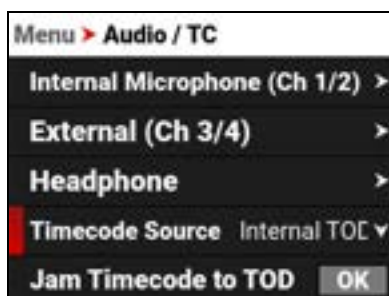

2. Select Timecode Source. The Timecode Source menu opens:

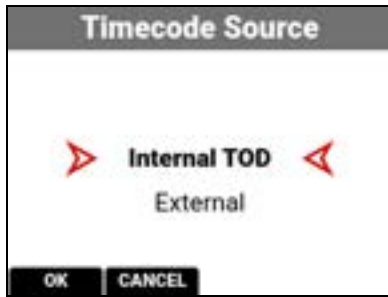

3. Select Internal TOD to use the camera's internal real time clock, or select External to use an external Timecode generator connected to the . Press the button under OK to confirm the selection.
4. When you select Internal TOD, you can navigate to **JAM Timecode to TOD** and press SEL to synchronize the Timecode to the camera's internal clock.

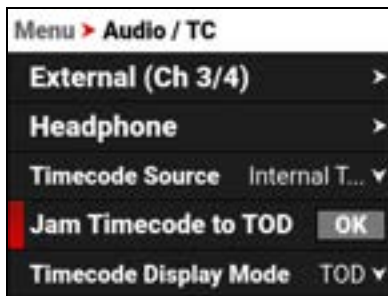

The camera displays the Timecode on the **LCD** Home page:



**NOTE:** The timecode is reset when the camera is turned off.

## EDGECODE

Edgecode only advances while the camera is recording frames. Each frame is sequential. When the media is replaced, the new media starts the timer over. You can set the Edgecode timer manually by using Secure Format (refer to [Secure Format](#) for more information).

### SETTING UP EDGECODE TIMECODE

To set up Edgecode Timecode on the camera, perform the following:

1. Open the Audio / Timecode menu: **Menu > Audio / TC:**



2. Navigate down to Timecode Display Mode:

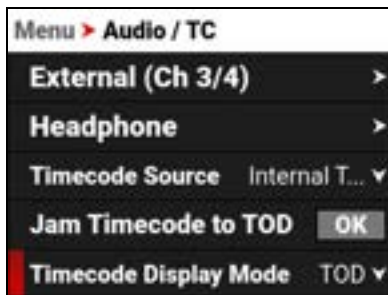

3. Press SEL to select Timecode Display Mode. The Timecode Display Mode menu opens:

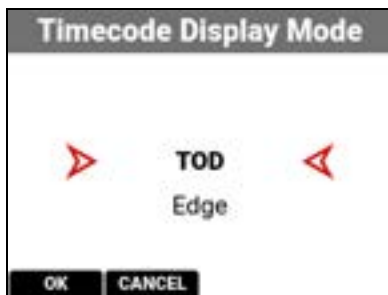

4. Select Edge and press the button under OK to use Edgecode. The camera displays the Edgecode on the LCD Home page:



**NOTE:** Each new media card will default to an edgecode track starting at 01:00:00. You can change the edgecode to begin at any desired time by using the Media Format menu (refer to [Edgecode](#)).

## ZEBRA MODES

Use Zebra modes to enable and adjust the upper and lower values for two (2) independent zebra indicators. Use Zebra 1 for highlight exposure, and use Zebra 2 for mid-tones or shadows. Zebras are disabled by default.

For more information, refer to the [Exposure with RED Cameras: False Color and Zebra Tools](http://www.red.com/red-101/exposure-false-color-zebra-tools) article, available at [www.red.com/red-101/exposure-false-color-zebra-tools](http://www.red.com/red-101/exposure-false-color-zebra-tools).

### ENABLING THE ZEBRA 1 INDICATOR

1. Go to **Menu > Monitoring > Tools** and select **Zebra 1**.
2. Set a Low IRE of 98.
3. Set a High IRE of 100.

Areas of the image exposed within the IRE range are indicated by red diagonal lines at  $-45^\circ$ .

The default settings are Low IRE = 98 and High IRE = 100.

### ENABLING THE ZEBRA 2 INDICATOR

1. Go to **Menu > Monitoring > Tools** and select **Zebra 2**.
2. Set a Low IRE of 41.
3. Set a High IRE of 48.

Areas of the image exposed within the IRE range are indicated by green diagonal lines at  $45^\circ$ .

The default settings are Low IRE = 41 and High IRE = 48.

## ZEBRA OVERVIEW

Zebra is a specialty mode that is capable of showing up to two customized overlays with arbitrary IRE ranges. Unlike the other two modes, Zebra indicators appear as diagonal stripes, they are fully configurable, and they have the advantage of preserving a full-color base image.

With traditional video cameras, many used a single zebra to indicate highlight detail. It would often be set at 70% (70 IRE), in part because this is where a white piece of paper would begin to have minimal texture when rendered using a typical contrast curve. Skin tones or skies would be exposed to appear just darker or brighter than these lines. If enabled, a second zebra would typically indicate either mid-tones or shadows. For deep shadows, you can set the second indicator to below 10% intensity or 10 IRE, and set the first indicator to highlights above 85 IRE.

However, as with other IRE-based modes, Zebra mode is only applicable for the current ISO settings (such as with SDI output), not for the raw image data. If anything is changed in post-production, the indicators won't be representative of the final output tones. In those situations, Zebra mode is more of a preview and output brightness tool than an exposure tool.

## PRE-RECORDING CONTENT

This section explains how to use the Pre-Record feature.

To start pre-recording, press the **Record** button.

The LCD changes from the Ready appearance to the Pre-Record appearance:



Press the **Record** button again to start recording.

When you start recording, the appearance of the LCD changes from the Pre-Record appearance to the Record appearance:



The camera adds the Pre-Record clip to the beginning of your recording.

For information about enabling and configuring Pre-Record, refer to [Pre-Record](#).

## CALIBRATING THE SENSOR

Sensor calibration is a process during which the camera optimizes image quality by ensuring that pixel sensitivity remains consistent throughout the sensor.

## WHEN TO CALIBRATE THE SENSOR

Calibration is required:

- When shooting in an environment where the temperature is significantly different (+/- 30° F...) from the current calibration. The T in the T/E Status Bar indicator will turn yellow (refer to [Status Bar](#) for more information)
- After an extreme change in exposure time (+/- 1/2 sec). The E in the T/E Status Bar indicator will turn yellow (refer to [Status Bar](#) for more information)
- After each firmware upgrade

## UPGRADING THE FIRMWARE

You can receive the best performance from your camera by installing the latest firmware. Make a habit of frequently visiting RED Downloads at [www.red.com/downloads](http://www.red.com/downloads) to check for new versions of camera firmware, updated operation guides, and post production software.

## VERIFYING THE FIRMWARE VERSION

To view the firmware version that is currently installed on your camera, open **Menu > System Settings > System Status > Camera Info**:

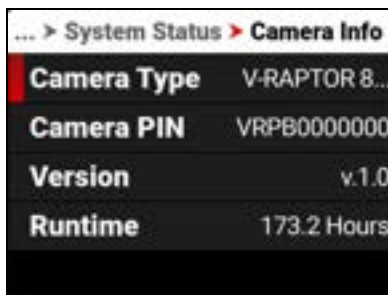

Version displays the currently installed camera firmware. A higher number reflects a newer release.

## UPGRADING THE FIRMWARE

Install the most recent firmware. Unless otherwise specified in the release notes, you do not need to upgrade to any firmware in between your current version and the most recent version available online.

**NOTE:** You must calibrate the sensor after upgrading the camera. For more information, refer to [Calibrating the Sensor](#).

1. Download the most recent firmware for your camera from RED Downloads at [www.red.com/downloads](http://www.red.com/downloads).
2. Unzip the firmware zip file.
3. In the unzipped folder, navigate to the **upgrade** folder.
4. Copy the **upgrade** folder and its contents to the root level of the CFexpress media card directory.
5. Unmount the CFexpress media card from your computer and remove the media card from the media reader.
6. Insert the CFexpress media card in the camera.

7. From the camera UI, navigate to **Menu > Maintenance**.



8. From the Maintenance menu, navigate down to Upgrade and press SEL .



The Firmware Upgrade confirmation screen displays:



9. Press the button under **UPGRADE** to confirm. The Firmware Upgrade progress screen displays:



During the upgrade, the fans run at high speed and the following occurs:

- The camera displays the **SHUTTING DOWN** screen and reboots
- The camera restarts and displays the **UPGRADING** screen
- The camera displays the **INITIALIZING** screen
- The camera displays the **FIRMWARE UPGRADE** progress screen:



The Firmware Upgrade success message screen displays with a **RESTART** button:



10. Press the button under **RESTART**. The camera displays the **SHUTTING DOWN** screen and reboots again.
11. The camera restarts displaying the V-RAPTOR 8K VV start screen, the **INITIALIZING** screen, and then the Software License Agreement (SLA) displays:



12. Press the button under **Agree**. If you do not agree to the SLA, the camera cannot be used. The SLA continues to display until it is accepted.
13. Recalibrate the camera before recording. Refer to the [Calibration](#) section and [Calibrating the Sensor](#) for more information.



## SYSTEM MAINTENANCE

All RED products are designed for rugged durability, but precision instruments demand proper care. Follow the instructions in this section to clean, maintain, and store your devices.

**WARNING:** DO NOT rinse or immerse the camera or other accessories in water. Keep dry at all times.

**WARNING:** DO NOT use soaps, detergents, ammonia, acetone, alkaline cleaners, abrasive cleaning compounds, or solvents. These substances may damage lens coatings and electronic circuitry.

**WARNING:** DO NOT use an excess of cleaning solution.

**WARNING:** DO NOT reuse swabs or wipes.

**WARNING:** DO NOT attempt to clean the sensor or optical cavity for any reason. If the sensor becomes dirty, submit a Support ticket at <https://support.red.com>.

**WARNING:** DO NOT attempt to modify, dismantle, or open the camera, lens, or other accessory as doing so may expose you to electric shock and serious injury. There are no user-serviceable parts inside. Alteration or repairs made to the camera or accessories, except by a RED authorized service facility, voids all warranties.

**WARNING:** Use caution with compressed air and gas dusters, since the high pressure, oily residue, cold air, particulates, and moisture may cause damage. You may use a filtered, non-residue gas duster to clean non-critical areas, such as around the fans and other recesses on the exterior of the camera. Damage to the camera or other components of the camera system caused by using compressed air or gas dusters is not covered under warranty.

**WARNING:** DO NOT use compressed air and gas dusters on the sensor or on any optics.

**WARNING:** DO NOT use compressed air and gas dusters on or around the integrated microphones on the front of the camera.

## EXTERIOR SURFACES

- Use a filtered, non-residue gas duster to clean non-critical areas, such as around the fans and other recesses on the exterior of the camera.
- Clean with a dry lint-free cloth. When cleaning your camera and accessories, remember that the devices are not waterproof and moisture can damage electronic circuitry.

## STORAGE

**WARNING:** DO NOT store the camera or accessories in any place with extreme temperatures, direct sunlight, high humidity, severe vibration, or strong magnetic fields.

## LCD SCREEN

This section explains how to clean the side LCD screen.

### APPROVED LCD SCREEN CLEANERS

Use only the following products to clean the side LCD screen:

- Ionized rubber air bulb
- Lens swabs
- Dry optical wipes
- Delkin Devices Sensor Solution®

**NOTE:** Before cleaning the screen with swabs or wipes and a cleaning solution, ALWAYS use an ionized rubber air bulb to remove any solid particles. Cleaning the screen without removing solid particles increases the risk of scratching the screen.

### PROHIBITED LCD SCREEN CLEANERS

DO NOT use any of the items listed below to clean the built-in LCD screen. These products have not been tested on RED products and may cause damage or streaking.

- Windex
- Solvents
- Gas dusters
- Compressed air
- Rubbing alcohol
- Isopropyl alcohol
- Third-party cleaning kits
- Pancro Professional Lens Cleaner (or equivalent)
- Pre-packaged lens cleaner containing any additives, such as detergent, anti-static compounds, or fragrance.

**WARNING:** Damage to the LCD screen or other components of the camera system caused by using prohibited cleaners is not covered under warranty.

## WATER DAMAGE

If your device has come in contact with water or you suspect camera water damage, submit a Support ticket at <https://support.red.com> immediately.

**WARNING:** DO NOT attempt to power any device that may have water damage.

**WARNING:** DO NOT place the device in a container of rice, silica gel, or desiccant packets in an attempt to dry the device.

## 6. TROUBLESHOOTING

### GENERAL TROUBLESHOOTING TIPS

This section describes general troubleshooting tips:

- Check the current firmware on the camera. If newer firmware is available from RED, download and install that firmware.
- Check the [Known Issues List](#) to see if the issue has already been identified by RED.
- Turn the camera off and on.
- Try using fresh media.
- Try different cables and make sure that the cables are properly attached.
- Remove all accessories and then re-attach them one-by-one. This process may help you identify whether the issue is specific to a particular accessory.
- Reset the camera to its default settings.





















### CONTACT SUPPORT

















If you are unable to resolve an issue, submit a [Support ticket](#). Include the following with the request:

- A Log file. For more information, go to [Save Log](#).
- A list of devices, lens, and third-party accessories that were attached when the issue occurred.
- The camera power source used when the issue occurred (include battery types, power devices, and power cables).
- A description of the issue that occurred.

## STATUS ICONS

The following is a table of the camera's status icons.

ICON	DETAILS
	The CFexpress media card is good and recording time remaining
	The CFexpress media card is missing
	The CFexpress media card is incompatible
	The sensor temperature (T) and exposure (E) calibration are good
	The sensor temperature (T) requires calibration
	The sensor exposure (E) requires calibration
	Gray indicates that no Timecode generator signal is detected
	Green indicates that the Timecode source is connected and jammed
	Red indicates that the Timecode source is connected and not jammed
	White indicates that the Timecode source is jammed and not connected
	Yellow indicates that the Timecode source is cross-jammed (at a different <b>Project Time Base</b> )
	Gray indicates that no Genlock signal is detected
	Green indicates that the camera is receiving and is locked to a Genlock signal
	Red indicates that the camera is receiving and is not locked to a Genlock signal
	Gray indicates that no synchronization is detected
	Green indicates that the camera's sensor is synchronized with Timecode and that the camera's output is synchronized with a Genlock signal
	Yellow indicates that the camera's sensor is <b>NOT</b> synchronized with Timecode and that the camera's output is synchronized with a single camera or a Genlock signal
	Camera temperature is good
	Camera overheating warning
	Camera overheating
	Camera shutting down
	Gray indicates no FTPS data is transferring

ICON	DETAILS
	Green arrows indicate FTPS data is transferring
	Gray and open indicates that the camera LCD is unlocked
	White and closed indicates that the camera LCD is locked
	Gray and empty indicates that no Wi-Fi signal is detected
	White bars indicate the strength of the Wi-Fi signal detected (Infrastructure)
	White antenna indicates that Wi-Fi signal is broadcasting (Ad-hoc)
	Gray indicates that the camera is not connected to a network
	Green indicates that the camera is connected to a network
	Gray indicates that no DC power is connected
	Green indicates that the camera is receiving DC power
	Gray indicates that no battery is connected
	White indicates that the battery is connected and green shows the relative level of charge remaining
	Yellow indicates 10 minutes of power remaining
	Red indicates less than 5 minutes of power remaining
	Gray question mark indicates no communication with the battery and no power
	White question mark indicates no communication with the battery and power
	Gray exclamation point indicates error communicating with the battery and no power

## 7. MECHANICAL DRAWINGS

**NOTE:** Dimensions are shown in mm.

### FRONT VIEW

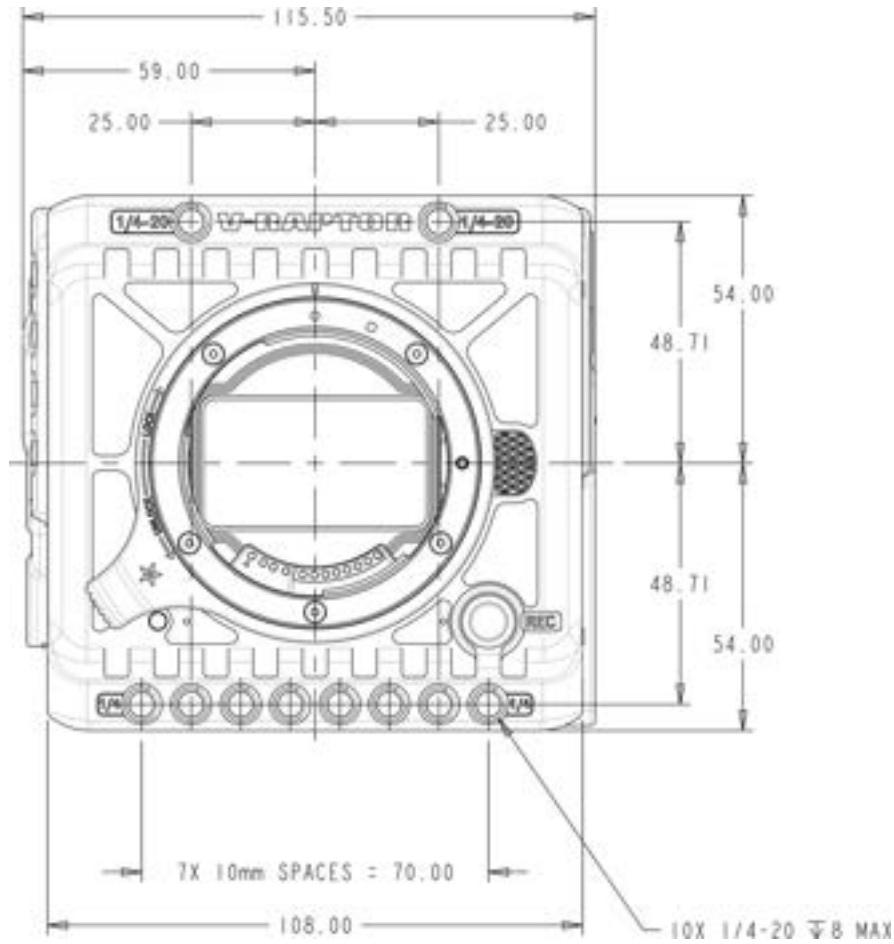

Figure: Camera Front View

## BACK VIEW

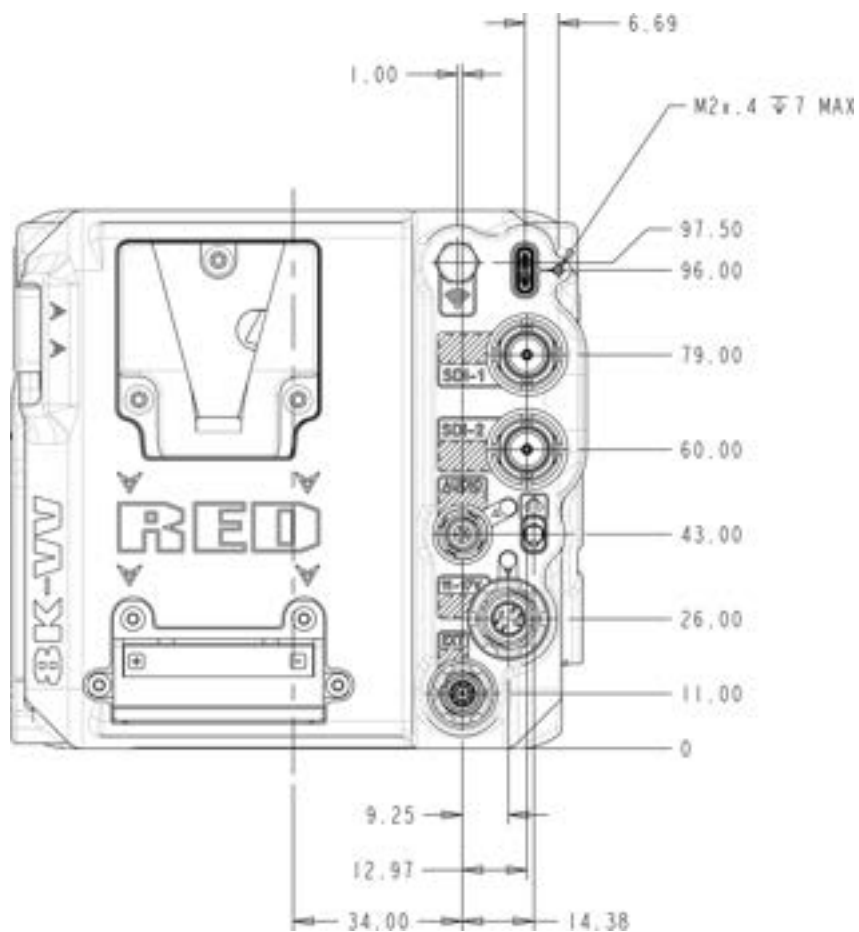

Figure: Camera Back View

## RIGHT SIDE VIEW

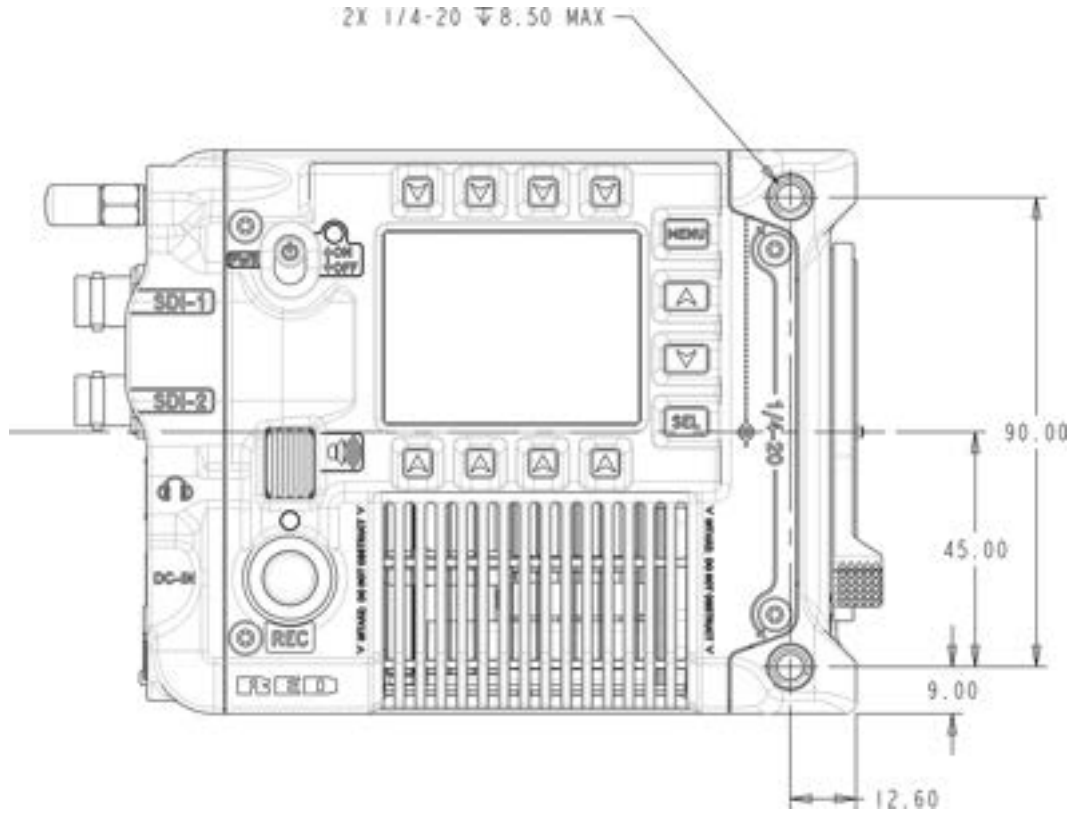

Figure: Camera Side View (Right)



### LEFT SIDE VIEW

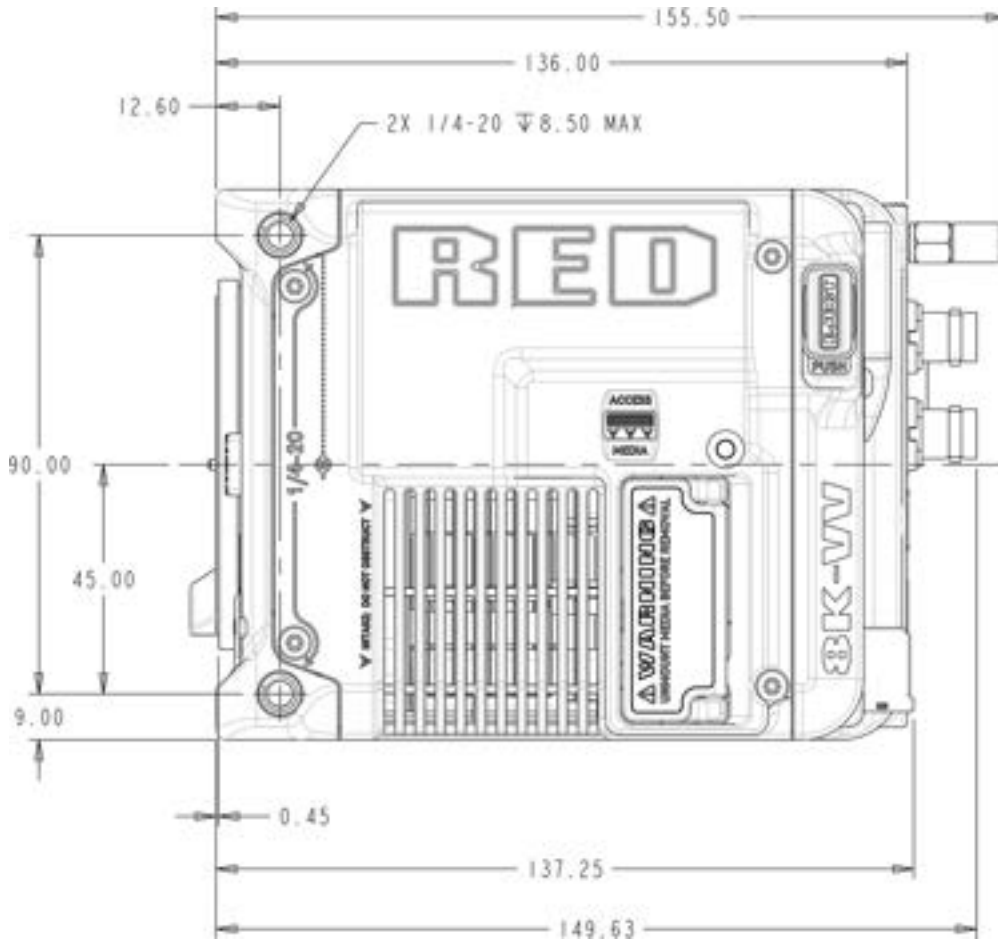

Figure: Camera Side View (Left)

**TOP VIEW**

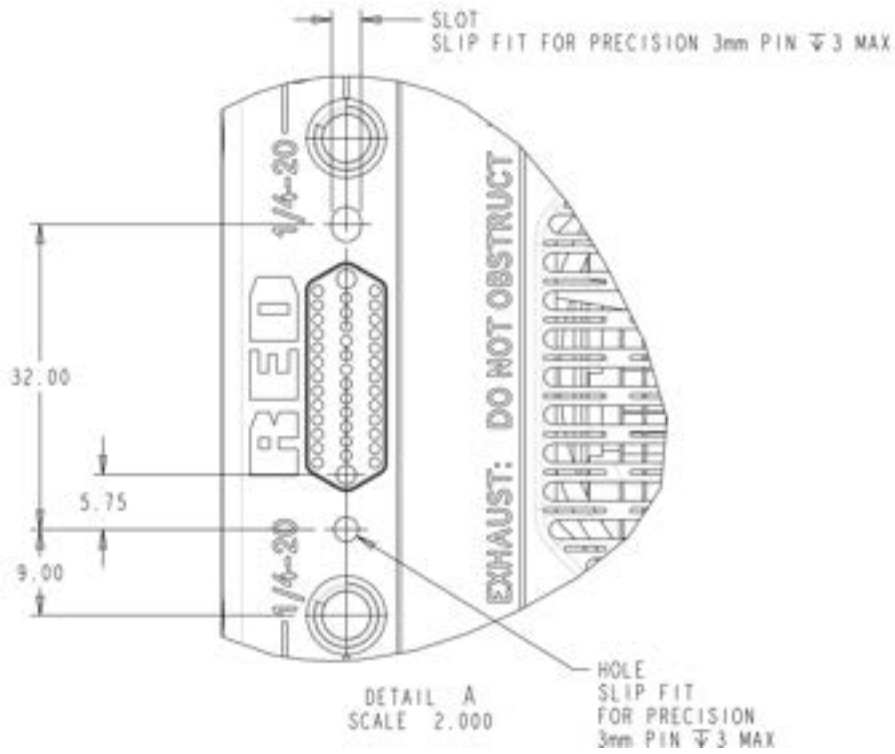
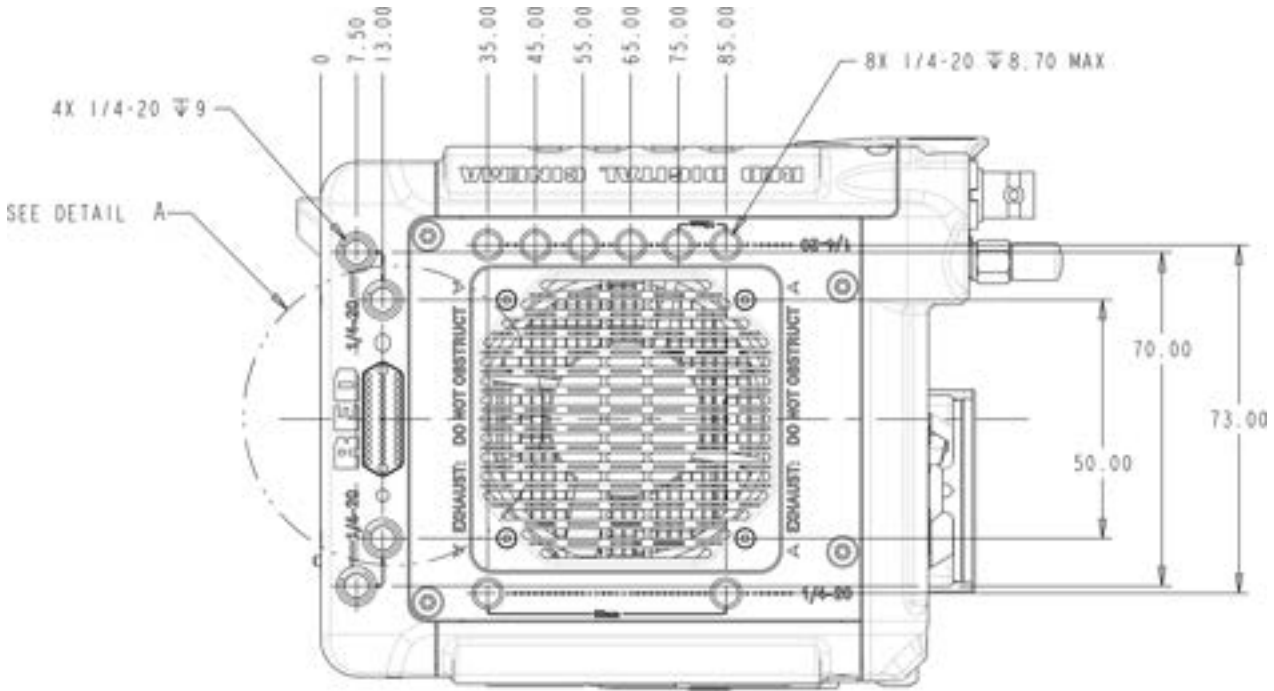

Figure: Camera Top View

## BOTTOM VIEW

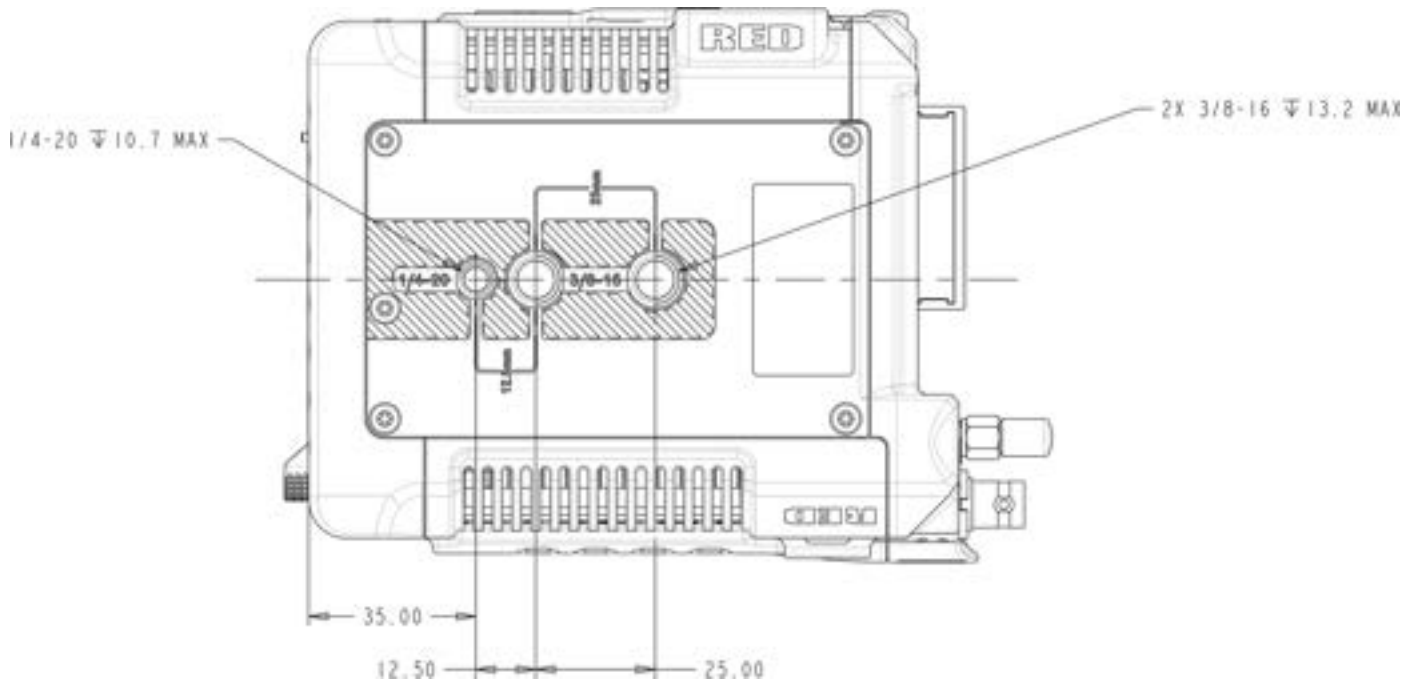

Figure: Camera Bottom View

## FEMALE RP SMA PORT

The female RP SMA connector provides an attachment for the male RP SMA Wi-Fi antenna.

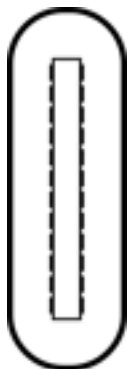

*Figure: Front face of the female RP SMA port (looking at the back of the camera).*

**NOTE:** Mating connector is a Wi-Fi antenna with a standard male RP SMA connector.

## USB-C PORT

The USB-C power out connector supplies 5 Volts of power. The maximum sustained current draw is 0.5 Amps. The USB-C port is used primarily for data connections.



*Figure: Front face of the USB-C port (looking at the back of the camera).*

**NOTE:** Mating connector is a standard USB-C male connector.

## 12G-SDI (SDI-1 & SDI-2)



The 12G-SDI male 75 ohm BNC ports deliver 12, 6, 3, or 1.5 Gbps of image bandwidth ideal for the 4Kp60 format. Other features include:

- Up to Four (4) channels of embedded audio
- Time of Day and Edge Timecode
- Record Tally flag
- Clip name information (as SMPTE RP-188 VITC2 HANC metadata)

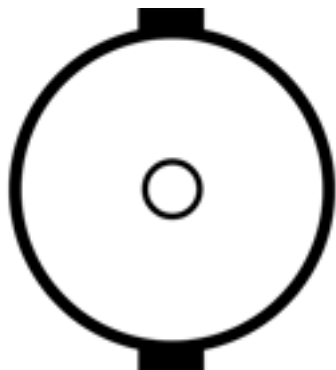

Figure: Front face of the 12G-SDI male BNC connector (looking at the back of the camera).

## 12G-SDI 75 OHM MALE BNC CONNECTOR

PIN	SIGNAL	DESCRIPTION	DIRECTION
Center	12/6/3/1.5 G-SDI Signal	Up to 4096 x 2160: 444 for 30p, 422 for 60p - Log view or LUT view (SMPTE ST 2082)	Out
Shell	Ground	Common ground (camera ground)	N/A

**NOTE:** Mating connector is standard 75 Female BNC connector rated for 12G-SDI.

**WARNING:** Under certain circumstances, it is possible for an SDI connector to incur damage when connected to an accessory and powered without using shielded cables. RED recommends only using high quality, shielded BNC cables that are rated for 12G-SDI signals and only using shielded power cables for powering SDI accessories.

Make sure power is connected to the SDI accessory at all times before you connect the BNC to the camera. Ungrounded power from SDI accessories can damage the camera's SDI port. To avoid this possible damage, attach the power source to the accessory before attaching it to the BNC cable. When using RED Approved Third Party battery plates, unplug the BNC cable prior to hot swapping.

When possible, avoid using P-Tap (also known as D-Tap) cables to power accessories. To avoid damage when using P-Tap/D-Tap, it's imperative that the connect/disconnect sequence (below) is followed precisely.

## **BNC ATTACHMENT INSTRUCTIONS**

When attaching SDI accessories:

1. Connect a power source to the SDI accessory; power on the SDI accessory.
2. Ensure a power source is connected to the camera. This ensures both are grounded prior to connecting the BNC. The camera's power state does not have an impact on SDI attachment sequence.
3. Connect the BNC cable to the accessory, then to the camera.

When detaching an accessory mounted to an SDI output, ensure that you remove the BNC connection to the camera before removing power to the SDI device:

1. Shutdown the SDI accessory.
2. Disconnect the BNC cable from the camera.
3. Disconnect the power source from the SDI accessory.

When you need to swap out a battery on an accessory mounted to the camera's SDI port, you must:

1. Shutdown the SDI accessory.
2. Disconnect the BNC cable from the camera.
3. Replace the battery on the SDI accessory.
4. Connect the BNC cable to the camera.
5. Power on the SDI accessory.

For more information, refer to [Preventing Damage to SDI Outputs](#).

## AUDIO PORT



The female 5-pin 00B audio connector accepts 2-channel audio, Line, Mic, and +48V Phantom Power.



Figure: Front face of the female 5-pin 00B audio connector (looking at the back of the camera).

## 5-PIN 00B FEMALE AUDIO CONNECTOR

PIN	SIGNAL	DESCRIPTION
1	Ground	Ground to camera
2	Ch 3 +	Channel 3 signal (positive)
3	Ch 3 -	Channel 3 negative
4	Ch 4 +	Channel 4 signal (positive)
5	Ch 4 -	Channel 4 negative

**NOTE:** Mating connectors are FGG.00.305.CLAD35Z (5-pin 00 circular push-pull connector, straight plug) and FHG.00.305.CLAD35Z (5-pin 00 circular push-pull connector, right-angle plug).



## HEADPHONE JACK

The female stereo 3.5 mm headphone jack provides an attachment for stereo headphones.

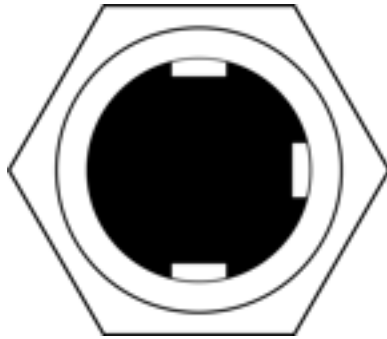

*Figure: Front face of the female 3.5 mm headphone jack (looking at the back of the camera).*

**NOTE:** Mating connector is a 3.5 mm stereo headphone plug.

## 6-PIN DC-IN



The male 6-Pin 1B DC-IN connector accepts DC input power from 11 V DC to 17 V DC. A built-in power conditioner protects against reverse-polarity connections, electrostatic discharge (ESD), undervoltage, overvoltage, and overcurrent.

**WARNING:** Both pairs of +VBATT and GROUND pins must be wired. Using a third-party power cable that wires only one (1) pair of +VBATT and GROUND pins may damage the power supply or the camera. Damage to the power supply or other components of the camera system caused by using an inappropriate power cable is not covered under warranty.

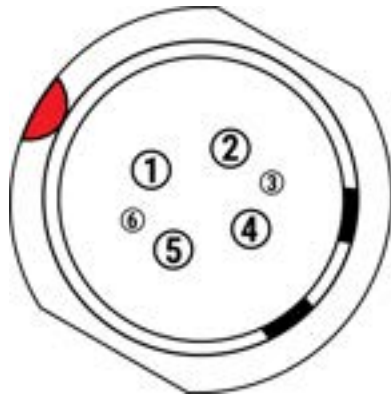

Figure: Front face of the male 6-pin 1B DC power input connector (looking at the back of the camera).

## 6-PIN 1B DC INPUT CONNECTOR

PIN	SIGNAL	DESCRIPTION
1	+VBATT	Power input, +11.5 to +17 V DC
2	+VBATT	Power input, +11.5 to +17 V DC
3	SCL-BATT	Battery SMBus SCL signal (3.3 V)
4	GROUND	Power return (camera ground)
5	GROUND	Power return (camera ground)
6	SDA-BATT	Battery SMBus SDA signal (3.3 V)

**NOTE:** Mating connector is FGJ.1B.306.CWLD72Z.

## COMPATIBLE CABLES

- **790-0638:** DSMC AC Power Adaptor Pack
- **790-0164:** XLR Power Cable (10')
- **790-0291:** DSMC Battery Belt Clip

## EXTENSION PORT



The female 9-contact 0B ODU Extension port supports serial (RS-232 RX and TX), a General Purpose Input (GPI) trigger (active-low switch closure), General Purpose Output (GPO), Timecode, and Genlock. The connector also offers auxiliary 5 Volt power out, with a maximum sustained current draw of 500 mA.

To operate the GPI contact closure style trigger, short Pin 6 (GPI) to Pin 9 (ground).

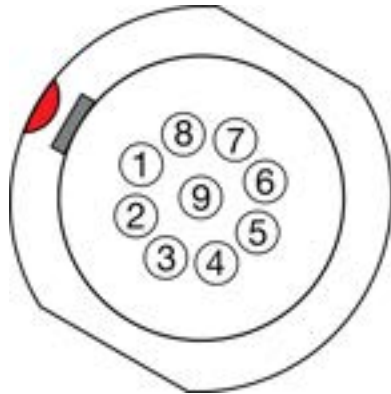

Figure: Front face of the female 9-contact Extension port (looking at the back of the camera).

**NOTE:** The required mating connector is 9-Pin 0L Straight Plug Connector (ODU, part# SX0L0X-P09MCC0-0001).

## 9-PIN 0B ODU EXTENSION PORT PINOUT

PIN	SIGNAL	DETAILS
1	5 V AUX	5 Volt AUX (500 mA Max) enabled using the <b>Power</b> menu
2	Timecode Out	Timecode Out – SMPTE 12M <sup>1</sup>
3	GPO	General Purpose Out, Sensor Sync, 3.3 Volt Logic Level
4	UART TX	Serial RS-232 Transmit
5	UART RX	Serial RS-232 Receive
6	GPI	General Purpose In, 3.3 Volt Logic Level <sup>2</sup>
7	Timecode In	Timecode In – SMPTE 12M
8	Genlock	Tri-Level Genlock In (SMPTE 296M and 274M)
9	GND	Signal and Power Ground

1. Not currently supported.

2. The signal path includes a resistor pulling the signal high, which is designed to work with a closure switch connected to GND.

## COMPATIBLE CABLES

- **790-0685:** RED 9-Pin EXT to Flying Lead 1.3'
- **790-0674:** RED EXT to Timecode 3'

# 8. MENU MAP

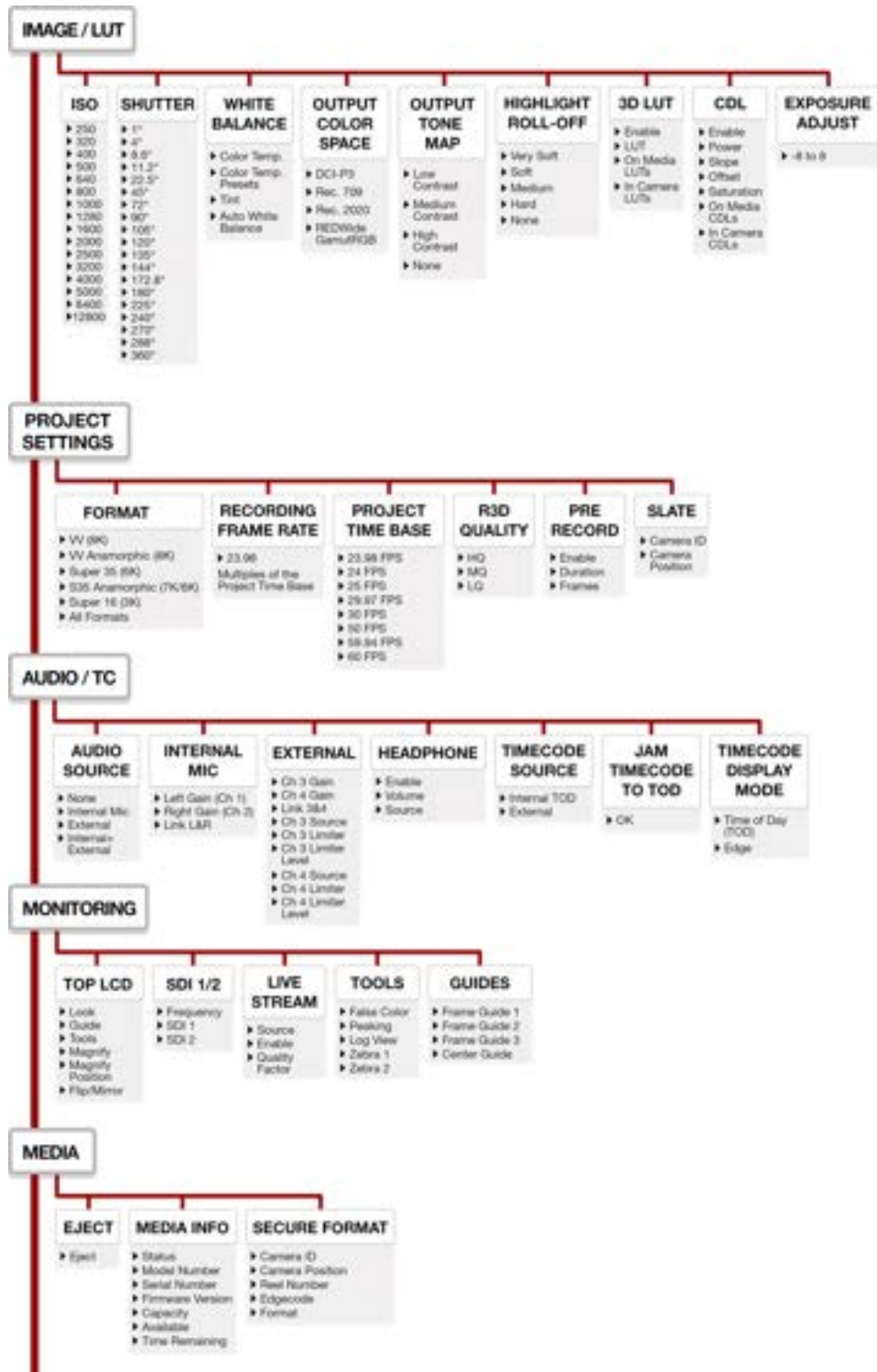

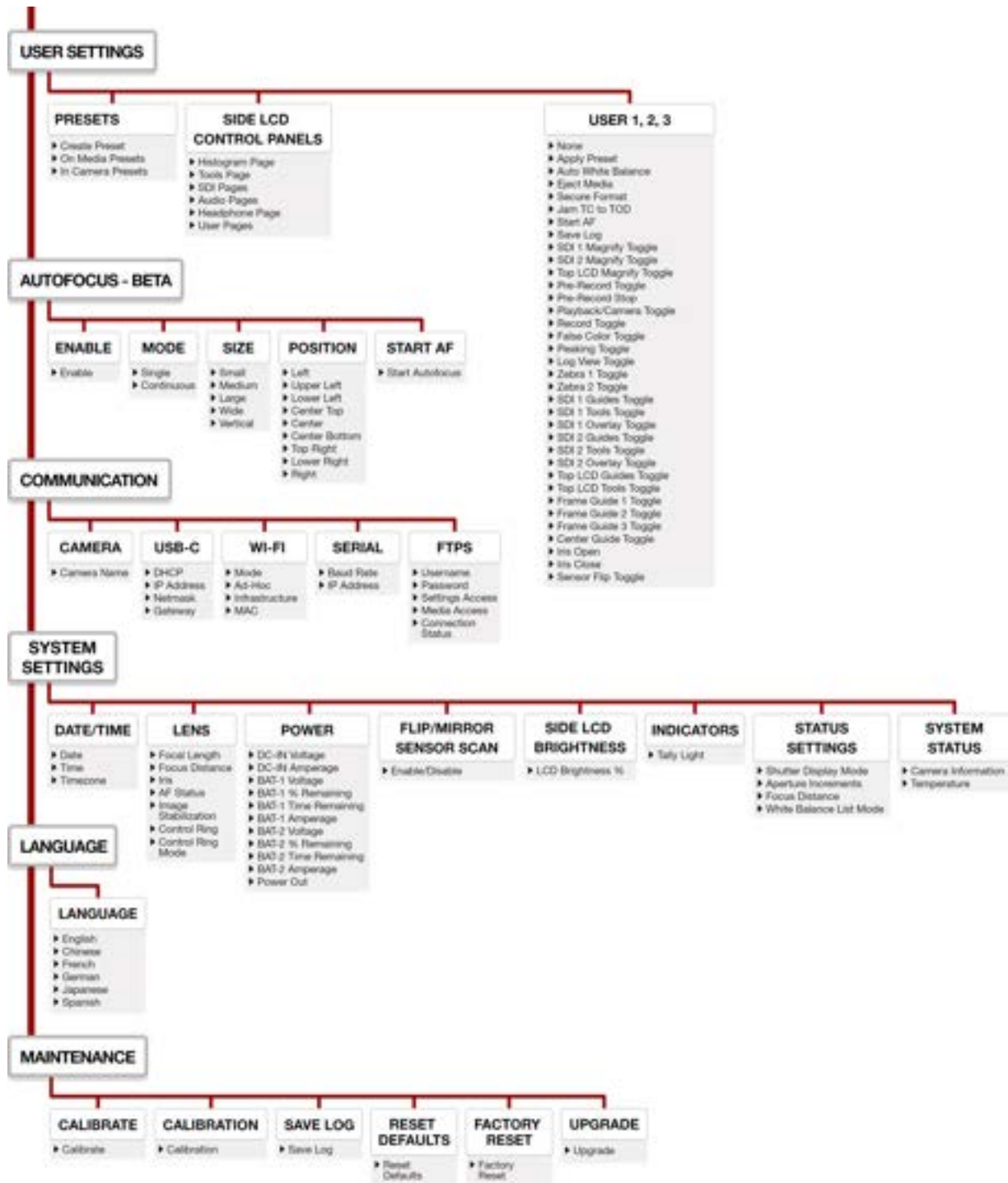

## 9. TECHNICAL SPECIFICATIONS

Technical specifications reflect both current and projected information. Everything is subject to change.

### V-RAPTOR™ 8K VV + 6K S35 (DUAL FORMAT)

ITEM	DETAILS						
Sensor Type	V-RAPTOR 8K VV 35.4 Megapixel, CMOS						
Effective Pixels	8192 x 4320						
Sensor Size	40.96 mm x 21.60 mm (Diagonal: 46.31 mm)						
Dynamic Range	17+ stops						
Mount Type	RF mount with electronic communication Supports Canon EF with electronic communication by using compatible Canon RF mount adapters Accepts Canon RF mount-based lens adaptors for diverse lens choices <sup>1</sup>						
Max Data Rates	Up to 800 MB/s using RED Pro CFexpress or other qualified CFexpress media cards <sup>1</sup>						
REDCODE® RAW Maximum Frame Rates	<table border="0"> <tr> <td>VV</td> <td>120 fps at 8K 17:9 (8192 x 4320), 150 fps at 8K 2.4:1 (8192 x 3456) 140 fps at 7K 17:9 (7168 x 3780), 175 fps at 7K 2.4:1 (7168 x 3024)</td> </tr> <tr> <td>Super 35</td> <td>160 fps at 6K 17:9 (6144 x 3240), 200 fps at 6K 2.4:1 (6144 x 2592) 192 fps at 5K 17:9 (5120 x 2700), 240 fps at 5K 2.4:1 (5120 x 2160) 240 fps at 4K 17:9 (4096 x 2160), 300 fps at 4K 2.4:1 (4096 x 1728)</td> </tr> <tr> <td>Super 16</td> <td>320 fps at 3K 17:9 (3072 x 1620), 400 fps at 3K 2.4:1 (3072 x 1296) 480 fps at 2K 17:9 (2048 x 1080), 600 fps at 2K 2.4:1 (2048 x 864)</td> </tr> </table>	VV	120 fps at 8K 17:9 (8192 x 4320), 150 fps at 8K 2.4:1 (8192 x 3456) 140 fps at 7K 17:9 (7168 x 3780), 175 fps at 7K 2.4:1 (7168 x 3024)	Super 35	160 fps at 6K 17:9 (6144 x 3240), 200 fps at 6K 2.4:1 (6144 x 2592) 192 fps at 5K 17:9 (5120 x 2700), 240 fps at 5K 2.4:1 (5120 x 2160) 240 fps at 4K 17:9 (4096 x 2160), 300 fps at 4K 2.4:1 (4096 x 1728)	Super 16	320 fps at 3K 17:9 (3072 x 1620), 400 fps at 3K 2.4:1 (3072 x 1296) 480 fps at 2K 17:9 (2048 x 1080), 600 fps at 2K 2.4:1 (2048 x 864)
VV	120 fps at 8K 17:9 (8192 x 4320), 150 fps at 8K 2.4:1 (8192 x 3456) 140 fps at 7K 17:9 (7168 x 3780), 175 fps at 7K 2.4:1 (7168 x 3024)						
Super 35	160 fps at 6K 17:9 (6144 x 3240), 200 fps at 6K 2.4:1 (6144 x 2592) 192 fps at 5K 17:9 (5120 x 2700), 240 fps at 5K 2.4:1 (5120 x 2160) 240 fps at 4K 17:9 (4096 x 2160), 300 fps at 4K 2.4:1 (4096 x 1728)						
Super 16	320 fps at 3K 17:9 (3072 x 1620), 400 fps at 3K 2.4:1 (3072 x 1296) 480 fps at 2K 17:9 (2048 x 1080), 600 fps at 2K 2.4:1 (2048 x 864)						
Playback Frame Rates (Project Time Base)	23.98, 24, 25, 29.97, 30, 50, 59.94, and 60 fps, at all resolutions						
Best Available REDCODE® Settings	REDCODE HQ, MQ, and LQ at 8K 17:9 (8192 × 4320) up to 60 fps REDCODE LQ at 8K 17:9 (8192 × 4320) up to 120 fps REDCODE HQ, MQ, and LQ at 6K 17:9 (6144 × 3240) up to 96 fps REDCODE MQ, and LQ at 6K 17:9 (6144 × 3240) up to 160 fps REDCODE HQ, MQ, and LQ at 4K 17:9 (4096 × 2160) up to 240 fps REDCODE HQ, MQ, and LQ at 2K 17:9 (2048 × 1080) up to 480 fps						
REDCODE RAW Acquisition Formats	8K 17:9 (8192 x 4320), 2:1, 2.4:1, 16:9, 1:1 and Anamorphic 2x, 1.8x, 1.6x, 1.5x, 1.3x, 1.25x 7K 17:9 (7168 x 3780), 2:1, 2.4:1, 16:9, 1:1 and Anamorphic 2x, 1.8x, 1.6x 6K 17:9 (6144 x 3240), 2:1, 2.4:1, 16:9, 1:1 and Anamorphic 1.5x, 1.3x, 1.25x 5K 17:9 (5120 x 2700), 2:1, 2.4:1, 16:9, 1:1 4K 17:9 (4096 x 2160), 2:1, 2.4:1, 16:9, 1:1 3K 17:9 (3072 x 1620), 2:1, 2.4:1, 16:9, 1:1 2K 17:9 (2048 x 1080), 2:1, 2.4:1, 16:9, 1:1						
Construction	Aluminum Alloy						
Weight	4.03 lb without the body cap and the CFexpress Type B media card						
Battery Type	Integrated V-Lock battery interface optimized for the REDVOLT Micro-V Battery and other Micro V-Lock batteries <sup>1</sup>						
DC Power	+11 to +17 volts DC using the integrated 6-Pin DC-IN port						
Operating Temperature	0° C to 40° C (32° F to 104° F)						
Storage Temperature	-20° C to 50° C (-4° F to 122° F)						

## V-RAPTOR™ 8K VV + 6K S35 (DUAL FORMAT)

ITEM	DETAILS
Relative Humidity	0% to 85% non-condensing
Color Management	Image Processing Pipeline 2 (IPP2) Supports 33×33×33 3D LUTs Supports import of CDLs
Audio	Integrated dual channel digital mono microphones, uncompressed, 24-bit 48 kHz Integrated dual channel mic/line/+48 V input through the 5-pin Audio Port, uncompressed, 24-bit 48 kHz
Remote Control	Wi-Fi for camera control through interchangeable male RP SMA antenna to female RP SMA connection. Genlock, Timecode In, GPIO and Ctrl (RS-232) using the integrated 9-pin EXT Port. Wired control using the USB-C port or Gigabit Ethernet (compatible USB-C to Ethernet adapter <sup>1</sup> required) allowing remote camera control, live MJPEG preview video feed, and remote media offload
Monitor Outputs	Integrated 12G-SDI with 6G-SDI, 3G-SDI, and 1.5G-SDI modes 12G-SDI: Up to 4096 × 2160 4:2:2 for 60p 6G-SDI: Up to 4096 × 2160 4:2:2 for 30p, 25p, and 24p 3G-SDI: Up to 2048 × 1080 4:2:2 for 60p 1.5G-SDI: Up to 2048 × 1080 4:2:2 for 30p, 25p, and 24p SMPTE Timecode, HANC metadata, and 24-bit 48 kHz audio
Monitor Options	DSMC3 RED® Touch 7" LCD (top LCD) Wireless 1080p live preview video feed through 2.4 GHz or 5 GHz Wi-Fi for framing Integrated 2.4" LCD for camera control (no preview video)

## SOFTWARE

RED Control App	Access full camera controls and live preview from iOS or Android devices Available from the Apple App Store and Google Play Store. RED Control works wirelessly or wired through the USB-C port
-----------------	--

1. For more information on accessories, refer to [RED.com/third-party-accessories](https://www.red.com/third-party-accessories)